

Contents

Features	2	Other Features	24
Safety Precautions	2	TV Status.....	24
LCD TV	4	Mute Indicator	24
Remote Control Buttons	6	Freeze Picture.....	24
Before Switching On Your TV	7	Zoom Modes	25
Power Connection	7	Teletext	26
Connections To The Aerial Input Socket	7	To Operate Teletext	26
How To Connect Other Devices	7	To Select A Page Of Teletext	26
Inserting Batteries In The		To Select Index Page	26
Remote Control Handset	7	To Select Teletext With A	
Switching The TV ON/OFF	7	TV Programme	26
To switch the TV on:.....	7	To Select Double Height Text	26
To switch the TV off:	7	To Reveal "Concealed" Information ...	26
Initial Settings	8	To Stop Automatic Page Change.....	26
Basic Operations	9	To Select A Subcode Page	26
Everyday Operation	9	To Exit Teletext	27
Information Banner	9	To Display The Time	27
Electronic Programme Guide (EPG) ..	10	Fastext	27
Displaying The Subtitles	11	Connect Peripheral Equipment	27
Digital Teletext	11	High Definition	27
Over Air Download	11	Via The Scart	27
Widescreen	12	Via Aerial Input	27
IDTV Menu System.....	12	Decoder.....	28
Channel List	12	TV And Video Recorder.....	28
Installation	14	Playback NTSC	28
Configuration	15	Copy Facility	28
Timers	17	Search For And Store The	
Language	18	Test Signal Of The Video Recorder....	28
TV Setup	18	Camera And Camcorder	28
Common Interface	18	To Connect To S-Video Input	28
Analogue TV Menu System	19	Connect The Decoder To The	
Picture menu	19	Video Recorder	28
Sound menu	20	Connecting Headphones.....	28
Feature menu	21	Aerial Connection	29
Install menu	22	Trouble Shooting Guide	30
Program menu	23	Care of the Screen	30
Source menu	24	Specifications	31
		Important Instruction	32

Features

- Remote controlled colour television.
- 100 programmes from VHF, UHF bands or cable channels can be preset.
- It can tune cable channels.
- Controlling the TV is very easy by its menu driven system.
- It has 2 Scart sockets for external devices (such as video, video games, audio set, etc.)
- Stereo sound system (German+Nicam).
- Full function Teletext .
Fastext (1000 Pages), TOP text.
- Headphone connection.
- Direct channel access.
- A.P.S. (Automatic Programming System).
- All programmes can be named.
- Forward or backward automatic tuning.
- Sleep timer.
- Child Lock.
- Automatic sound mute when no transmission.
- NTSC Playback.
- AV in and S-Video in are available
- It has an HDMI connector for Digital Video and Audio. This connection is also designed to accept High Definition signals.
- AVL (Automatic Volume Limiting)
- When no valid signal is detected, after 5 minutes the TV switches itself automatically to stand-by mode.
- Stereo PC Audio Input
- PLL (Frequency Search)
- 3D Comb Filter

Safety Precautions

Please read the following recommended safety precautions carefully for your safety

1. Power Source

The set should be operated only from a 230-240V 50Hz supply.

2. Power Cord

Do not place the set, a piece of furniture, etc. on the power cord (mains lead) or pinch the cord. Handle the power cord by the plug. Do not pull out the plug by tugging the cord and never touch the power cord when your hands are wet as this could cause a short circuit or electric shock. Never make a knot in the cord or tie it with other cord. The power cord should be placed in such a way that they are not likely to be stepped on.

A damaged power cord can cause fire or give you an electric shock. When it is damaged and need to be changed, it should be done by qualified personnel.

3. Moisture and Water

Do not use this equipment in a humid and damp place (avoid the bathroom, the sink in the kitchen, and near the washing machine). Do not expose this equipment to rain or water, as this may be dangerous and do not place objects filled with liquids, such as flower vases on top of the set. Avoid from dripping or splashing.

If any solid object or liquid falls into the cabinet, unplug the set and have it checked by qualified personnel before operating it any further

4. Cleaning

Before cleaning, unplug the set from the wall outlet. Do not use liquid or aerosol cleaners. Use soft and dry cloth.

5. Ventilation

The slots and openings on the back cover are intended for ventilation and to ensure reliable operation. To prevent overheating, these openings must not be blocked or covered in anyway.

6. Heat and Flames

The set should not be placed near to naked flames and sources of intense heat, such as an electric heater. Ensure that no naked flame sources, such as lighted candles, are placed on top of the set

7. Lightning

In the event of a Thunderstorm or when going on holiday. Disconnect the mains supply and aerial (if external).

8. Replacement Part

When replacement parts are required, be sure the service technician has used replacement parts which are specified by the manufacturer or have the same specifications as the original one. Unauthorised substitutions may result in fire, electrical shock, or other hazards.

9. Servicing

Please refer all servicing to qualified personnel. Do not remove the cover yourself as this may result in an electric shock.

WARNING: When the device is not in use for a long time, disconnect from power.

Instructions for waste disposal:

- Packaging and packaging aids are recyclable and should principally be recycled. Packaging materials, such as foil bag, must be kept away from children.
- Battery, including those which is heavy metal-free, should not be disposed of with household waste. Please dispose of used battery in an environmentally sound manner. Find out about the legal regulations which apply in your area.
- Cold cathode fluorescent lamp in LCD PANEL contains a small amount of mercury, please follow local ordinances or regulations for disposal.

- The mains plug is used to disconnect the TV from the mains and therefore it shall remain readily operable.

Warning: To prevent injury, this device must be securely attached to the floor/wall in accordance with the installation instructions.

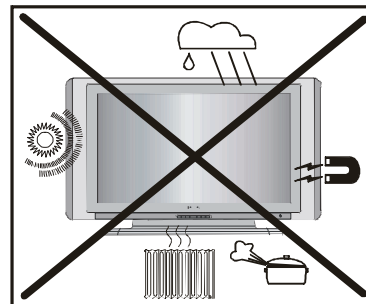
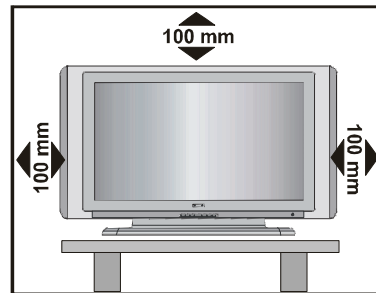

"The LCD panel is very high technology product with about a million thin film transistors, giving you fine picture details. Occasionally, a few non-active pixels may appear on the screen as a fixed point of blue, green or red. Please note that this does not affect the performance of your product."

"DO NOT LEAVE YOUR TV IN STANDBY OR OPERATING WHEN YOU LEAVE YOUR HOUSE"

Be sure to ground the connection properly.

Connect the ground terminal of TV with the ground terminal provided at the power outlet using the enclosed power cord. If the provided plug does not fit your outlet, consult an electrician for replacement of the obsolete outlet.



Surely connect the ground wire.

LCD TV

FRONT VIEW

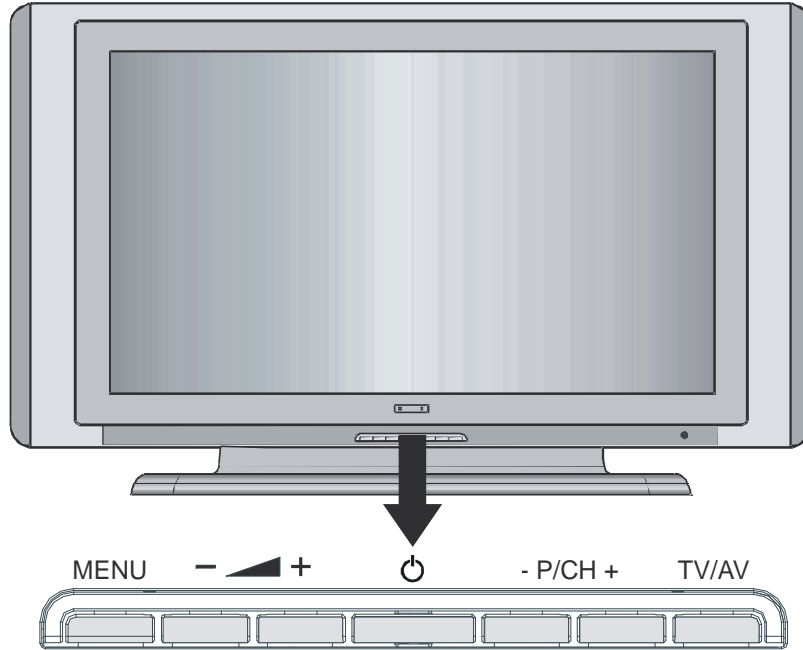

REAR VIEW

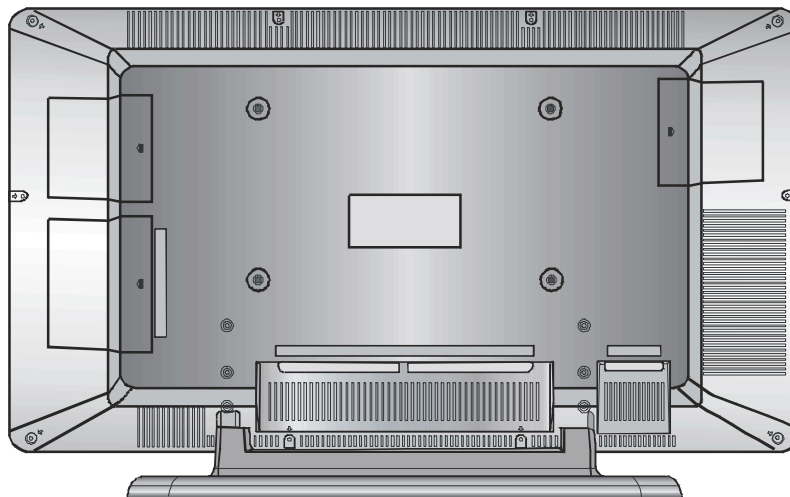

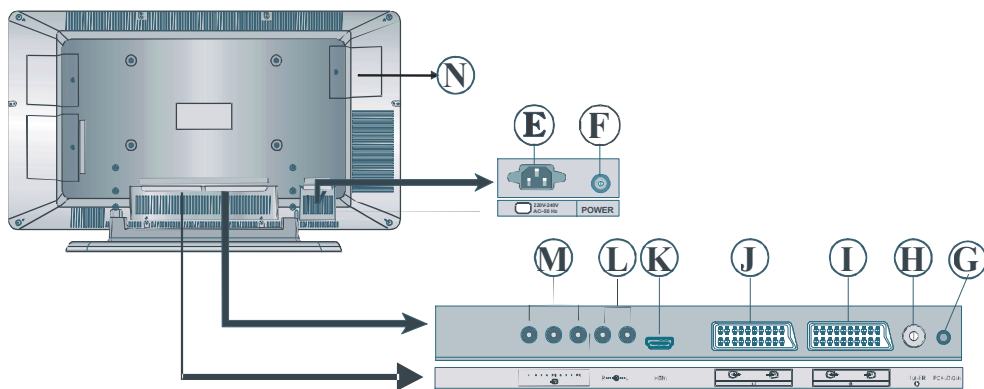
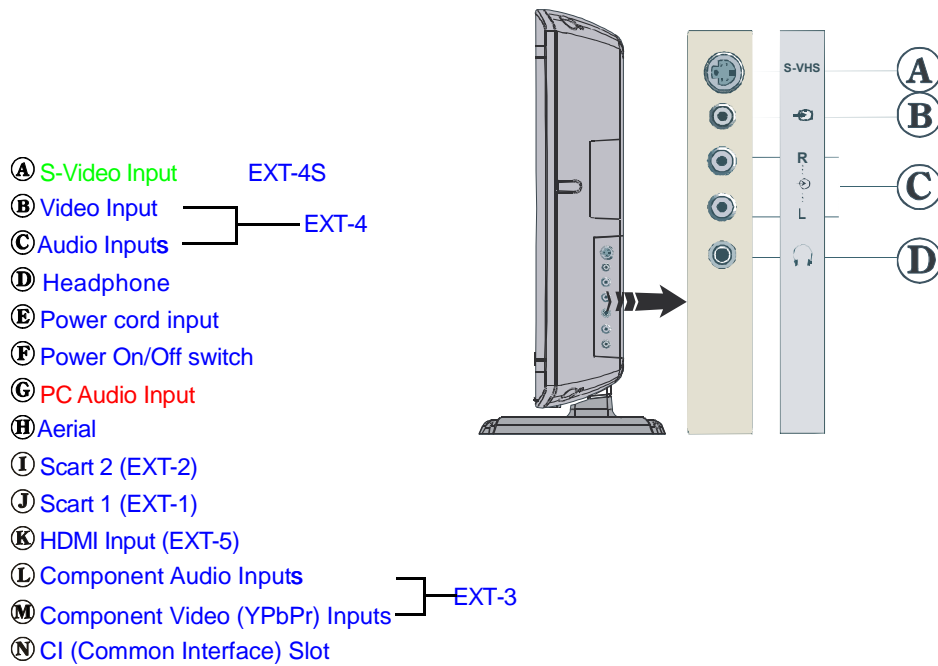

Remote Control Buttons

- ① = Stand By
- ② = Cursor Up
- ③ = Cursor Right
- ④ **OK / SELECT** = Okay, Freeze
(In Analogue Broadcast)
- ⑤ **0 - 9** = Direct Programme
- ⑥ **EXIT / -/-** = Exit menu / double digit
- ⑦ **P<P / SWAP** = previous programme /
programme swap
- ⑧ **P/CH +** = Programme Up
- ⑨ = Volume Up
- ⑩ = TV / No function
- ⑪ **SOURCE /** = External source
- ⑫ **YELLOW ***
- ⑬ **BLUE ***
- ⑭ = Hold / PIP position (No function)
- ⑮ = Update / **PAP Mode** (No function)
- ⑯ / **GUIDE** = Index Page /
Electronic Programme Guide (EPG) *
- ⑰ = Reveal
- ⑱ / **WIDE** = Expand / Image size
- ⑲ = Mix, = **PIP mode** (No function)
- ⑳ = Teletext
- ㉑ = Time / Subpage
- ㉒ / **RED** = Page Down / *
- ㉓ / **GREEN** = Page Up / *
- ㉔ = Mute
- ㉕ **I-II** = Mono/Stereo - Dual A-B
- ㉖ = Volume Down
- ㉗ **- P/CH** = Programme Down
- ㉘ **PP** = Personal settings
- ㉙ **INFO** = Information button (Program Table)
- ㉚ **M** = Menu
- ㉛ = Cursor Down
- ㉜ = Cursor Left

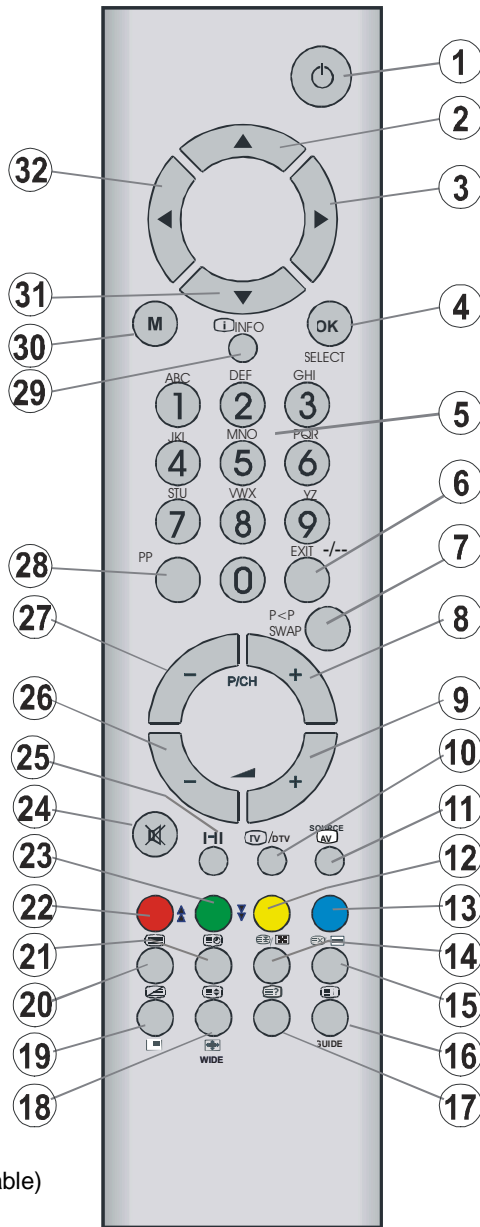

Before Switching On Your TV

Power Connection

IMPORTANT: The TV set is designed to operate on **230-240V AC, 50 Hz.**

- After unpacking, allow the TV set to reach the ambient room temperature before you connect the set to the mains.

Connections To The Aerial Input Socket

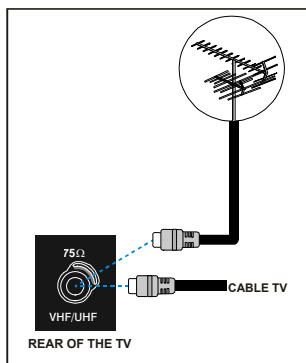

- Connect the aerial to the aerial socket on the TV, you may also connect a VCR or other box at the same time.

How To Connect Other Devices

IMPORTANT: Switch off the TV before connecting any external device.

Sockets for external connections are at the rear side of the TV. For connection of other devices via Scart refer to the manuals of the related devices.

Inserting Batteries In The Remote Control Handset

- Remove the battery cover located on the back of the handset by gently pulling downwards from the indicated part.
- Insert two **AA/R6** or equivalent type batteries inside. Place the batteries in the right directions.
- Replace the battery cover.

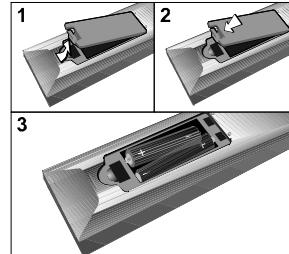

NOTE: Remove the batteries from remote control handset when it is not to be used for a long period. Otherwise it can be damaged due to any leakage of batteries.

Switching The TV ON/OFF

To switch the TV on:

Your TV will switch on in two steps:

- 1- Connect the power supply cord to the system. Press On/Off switch at the rear of the TV. Then the TV switches itself to stand-by mode and the LED becomes BLUE located on the front of the TV.

- 2- To switch on the TV from stand-by mode either:

Press a digit button on the remote control so that a programme number is selected,

or,

Press "⏻", "-P/CH" or "P/CH+" button on the right side of the TV or press "-P/CH" or "P/CH+" button on the remote control, so that last switched off programme is selected.

By either ways the TV will switch on and the LED will turn off.

To switch the TV off:

- Press the "stand-by" button on the remote control, so the TV will switch to stand-by mode and the LED will become **BLUE**,

or,

Press the "⏻" button located on the right side of the TV, so the TV will switch off and the LED will become **BLUE**.

To power down the TV completely, press On/Off switch,

or

unplug the power cord from the mains socket.

Initial Settings

When the TV is turned on for the first time, it is in the digital mode.

Because this is the first time the TV is used, there are no channels stored in the memory and the following message appears on the screen.

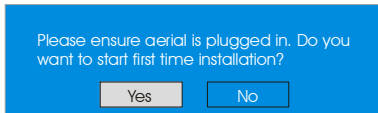

- To start installation process, select **“Yes”**, to cancel select **“No”**.

- To select an option **“Yes or No”**, highlight the item by using ◀ or ▶ buttons and press the **“OK”** button.

The IDTV will automatically tune to the UHF transmission channels 21 to 68 looking for digital terrestrial TV broadcasts and displaying the names of channels found. This process will take about five minutes. To cancel searching, you can press the **“M”** button at any time during the process.

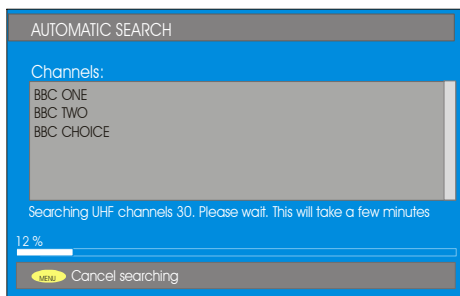

After **Automatic Search** process is completed, the following message asking for analogue channel search appears on the screen. TV switches to the analogue TV mode.

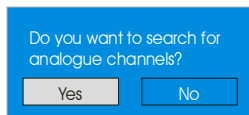

To search for analogue channels, select **“Yes”**. The menu below is displayed to search for analogue channels.

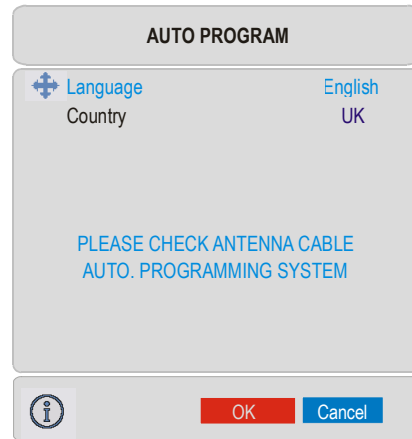

By pressing ◀ or ▶ button, adjust the **“Country”** item.

Press ▼ button to select **“Continue”** item and ◀ / ▶ or **OK** buttons to start APS operation.

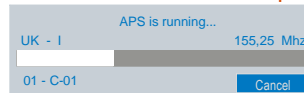

After **APS** is finalized, a programme list will appear on the screen. In the programme list you will see the programme numbers and names assigned to the programmes.

If you do not accept the locations and / or the programme names of programmes, you can change them in Program menu. For details see Program menu on page 23.

To display channel list in IDTV, switch to the IDTV via pressing the **“TV/DTV”** button. Then press the **“M”** button to enter main menu, **Channel List** will be highlighted. Press the **“SELECT”** button to enter the menu. For detailed information see page 12.

Basic Operations

You can operate your TV using both the remote control and onset buttons.

Operation with the buttons on the TV

Volume Setting

- Press “▲-” button to decrease volume or “▲+” button to increase volume, so a volume level scale (slider) will be displayed at the middle of the bottom on the screen.

Programme Selection

- Press “P/CH +” button to select the next programme or “P/CH -” button to select the previous programme.

Entering Main Menu

- Press the “MENU” button to enter Main menu. In the Main menu select sub-menu using “P/CH -” or “P/CH +” buttons and enter the sub-menu using “▲-” or “▲+” buttons. To learn the usage of the menus, refer to the Menu System sections.

AV Mode

Press the “TV/AV” button at the control panel on the right side of the TV to switch your TV to AV modes.

Operation with Remote Control

The remote control of your TV is designed to control all the functions of the model you selected. The functions will be described in accordance with the menu system of your TV.

Functions of the menu system are described in the following sections.

Volume Setting

Press “▲+” button to increase volume. Press “▲-” button to decrease volume. A volume level scale (slider) will be displayed in the middle at the bottom of the screen.

Programme Selection (Previous or next programme)

- Press “P/CH -” button to select the previous programme.
- Press “P/CH +” button to select the next programme.

Programme Selection (direct access):

Press digit buttons on the remote control to select programmes between 0 and 9. TV will switch to the selected programme. To select programmes between 10 - 999 (for IDTV) or 10-99 (for analogue), press the digit buttons consecutively which programme you want to select (eg. for programme 27, first press 2 and then 7). When it is late to press second digit button only the first digit programme will be displayed. The limit of the delay time is 3 seconds.

Press directly the programme number to reselect single digit programmes.

Everyday Operation

Pressing the “TV/DTV” button at any time while watching television programmes will switch the TV set between displaying the digital terrestrial television broadcasting and its normal analogue broadcasting.

Information Banner

Whenever you change channel, using the “P/CH +” / “- P/CH” button or the digit buttons, TV displays the channel picture along with an information banner at the bottom of the screen. This will remain on the screen for approximately three seconds. The information banner can also be displayed at any time while watching TV by pressing the “INFO” button on the remote control.

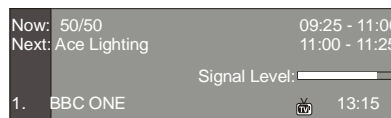

The information banner gives a number of facts on the channel selected and the programmes on it. The name of the channel is displayed, along with its channel list num-

ber and an indication of the strength of the signal received on this tuning channel.

Hint

Not all channels broadcast the programme data. If the name and times of the programme is not available then “No Information Available” are displayed in the information banner.

Icons are also displayed in the information banner and if this channel is a favourite channel:

Favourite channel icon .

If the selected channel is locked, you must enter the correct four digit code to view the channel.

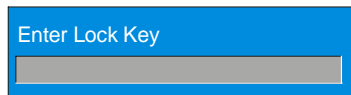

Electronic Programme Guide (EPG)

Some, but not all, channels send information about the current and next events. Please note that event information is updated automatically. If there is no event information data available in channels, only channel names with “No Information Available” banner is displayed.

- Press “GUIDE” button to view the EPG menu.
- In EPG Menu, you can easily see the extended help information by pressing “INFO” button and by pressing this button again you can close this window.

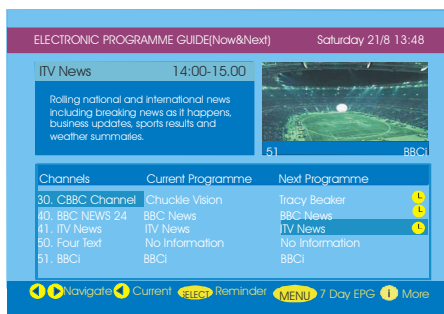

- In the EPG Menu all channels are displayed. Current channel is highlighted. Use

▲ or ▼ buttons to change channels. Also press ▲ or ▼ buttons to make page up/down scroll for the channels.

- If you highlight an event, short event description, extended event description, start and finish times of event are displayed on the screen.
- When the current programme is highlighted, the box is switched to the highlighted channel by pressing the “SELECT” button.
- If you press the “SELECT” button when a next event is highlighted, a reminder is set for the highlighted programme and a clock appears across the highlighted channel line.

Programme reminders can be set to signal that a programme is about to start when you are watching another channel. If you set reminder to a programme, then you will be asked for switching to that channel when the reminder time is reached.

- Press the “M” button to view the 7 day EPG.
- Press ▲ or ▼ button to navigate in Channels or Programmes.
- Press ◀ or ▶ button to navigate through the channel and programme list.

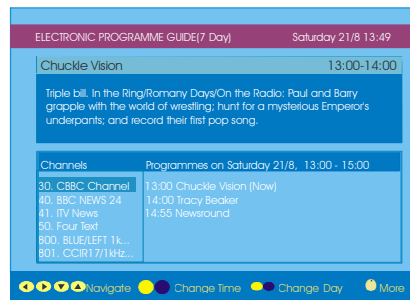

- With “RED/GREEN” buttons you can change schedule time. By pressing “YELLOW/BLUE” you can advance the schedule backward / forward of a day.
- If you press “INFO” button you can see the detailed help information easily. And by pressing “INFO” button again you can exit Help menu.
- The starting time for EPG is the current time. You can see the event information for

the next two hours. By pressing ▲ or ▼ button, you can go to the next/previous hours while Programmes list is highlighted.

- If you press the “SELECT” button when a next event is highlighted, a reminder is set for the highlighted programme and a clock appears on the screen. Programme reminders can be set to signal that a programme is about to start when you are watching another channel. If you set reminder to a programme, then you will be asked for switching to that channel when the reminder time is reached.



Displaying The Subtitles

With Digital terrestrial broadcasting (DVB-T), some programmes are broadcast with subtitles. Subtitles can be displayed when watching these programmes.

Press the “M” button to display the Main menu, highlight the Configuration line using ▲ or ▼ button and press the “SELECT” button to display the Configuration menu.

Highlight the “Subtitle” item in Configuration menu and use ◀ or ▶ button to set Subtitle to off or a language.

If “Subtitle” is on via selecting one language option, pressing the ☰ button causes the following warning message display on the screen.

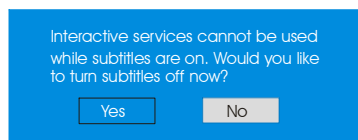

Digital Teletext

With Digital terrestrial broadcasting (DVB-T), in addition to pictures and sound, you can also watch digital teletext.

Digital teletext is sometimes broadcast at the same time as normal broadcasting.

1. Press the ☰ button.

The digital teletext information appears.

2. Operate it with the coloured buttons, ◀/▶/▲ buttons and OK button.

The operation method may differ depending on the contents of the digital teletext.

Follow the instructions displayed on digital teletext screen.

- When “Press SELECT” button or similar message appears on the screen, press the “SELECT” button.

- When the ☰ (Text) button is pressed, the TV returns to television broadcasting.

- With Digital terrestrial broadcasting (DVB-T), in addition to digital teletext broadcasting at the same time as normal broadcasting, there are also channels with just digital teletext broadcasting.

- The aspect ratio when watching a channel with just digital teletext broadcasting is the same as the aspect ratio of the picture watched previously.

- When you press the ☰ (Text) button again, the digital teletext screen is displayed.

Over Air Download

To ensure that your IDTV always has the most up-to-date information, please ensure that after use it is set to its standby mode. At 3AM each day, the IDTV automatically searches for any new information which may be broadcast and will download this to your IDTV automatically. This operation will normally take approximately 30 seconds.

If you want to do this, you need to set Automatic Download to “Enabled” in Receiver Upgrade setting. For details see page 16.

Widescreen

Depending on the type of broadcast being transmitted, programmes can be viewed in a number of formats. Press the “WIDE” button repeatedly to select between **Auto** or **16:9**.

When **Auto** is selected, the format being displayed is determined by the picture being broadcast.

Please Note: Menu size changes depending on the chosen image size.

IDTV Menu System

The IDTV menu can only be shown when watching Digital terrestrial broadcasting. Press the “TV/DTV” button to turn IDTV on while TV is in analogue mode.

Press the “M” button. The menu below appears on the screen:

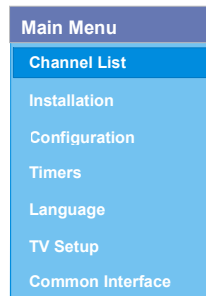

Channel List

Using the ▲ or ▼ button on the remote control in Main menu, make sure that the first item, Channel List, is highlighted and press the “SELECT” button to display the **Channel List**

The following operations can be performed in this menu:

1. Navigating the whole list of channels
2. Deleting channels
3. Renaming channels
4. Adding locks to channels
5. Setting favourites

Channel List is the place where the channels are managed.



Navigating the whole channel list

Press ▲ or ▼ button for selecting the previous or next channel. You can press ▲ or ▼ button to move page up or page down.

To watch a specific channel, highlight it using ▲ or ▼ button and then press “SELECT” button, while the “Select” item on Channel List menu is highlighted by using ◀ or ▶ button.

Then the name and number of the selected channel will be displayed in the top-left and top-right of the channel display at the top-right of the screen, respectively.

Deleting the channels in the channel list

Press ▲ or ▼ button to select the channel that will be deleted.

Press ◀ or ▶ button to select the “Delete” item on Channel List menu. As seen on Channel List menu, **SELECT** is written next to **Delete** item at the bottom of the screen to indicate that press the “SELECT” button to delete the highlighted channel in the channel list.



Press the “SELECT” button to delete the highlighted channel in the channel list. Then the message below appears on the screen.

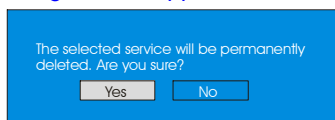

Press ◀ or ▶ button to highlight the desired option. If “SELECT” button is pressed while “Yes” is highlighted, the highlighted channel is deleted. Selecting “No” cancels the delete operation.

Renaming channels

To rename a specific channel, the channel must be highlighted via pressing ▲ or ▼ button and then highlight the **Edit Name** item by pressing ◀ or ▶ button. Press the “SELECT” to activate rename feature.

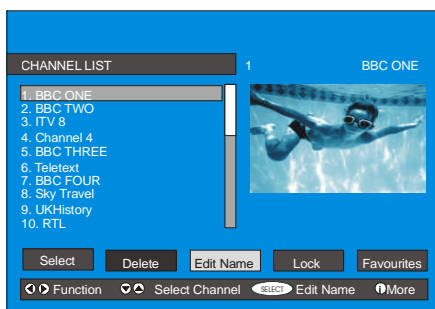

Now pressing ◀ or ▶ button moves to the previous/next character. Pressing ▲ or ▼ button toggles the current character, i.e., ‘b’ character becomes ‘a’ by ▼ and ‘c’ by ▲. Pressing the numeric buttons ‘0...9’ replaces the highlighted character with the characters printed above the button one by one as the button is pressed.

Press the “M” button to cancel the editing or “SELECT” button to save the new name.

Adding locks to channels

Channel Locking provides a password-protected access to channels selected by parents. In order to lock a channel you should know the Parental Lock password (default value is set to 0000 in the factory and can only be changed from the **Configuration Menu**).

Select the channel to be locked by highlighting it and select the “Lock” option by pressing ◀ or ▶ button. When the “SELECT” button is pressed, a password box is displayed.

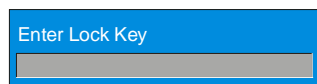
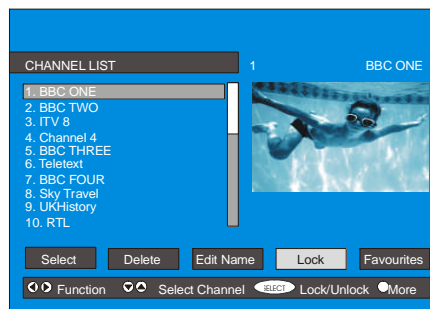

Enter the password using the digit buttons on the remote control. The Lock icon  will now be displayed next to the selected channel. Repeat the same operation to cancel the Lock.

Setting Favourites

You can set various channels as favourites so that only the favourite channels are navigated. To set a favourite you should highlight the “Favourites” item at bottom of the Channel List menu.

Use the ◀ or ▶ button to highlight the “Favourites” item at the base of the screen and then, in turn, highlight each channel you want to add to the favourites list, using the ▲ and ▼ buttons (or ▲ / ▼ buttons), and press the “SELECT” button.

A channel selected as a favourite appears in the main channel list with a favourites icon (😊) against the channel name.



On Screen Help Pressing INFO Button

For all menus press the “INFO” button to display the help information about the menu functions. For **Channel List** menu the following message is displayed on the screen.

Press the SELECT button on your remote control to tune to the highlighted channel.
Press MENU to exit this screen.

Installation

The Installation menu mainly intends to help you for building a **Channel Table** in the most efficient way.

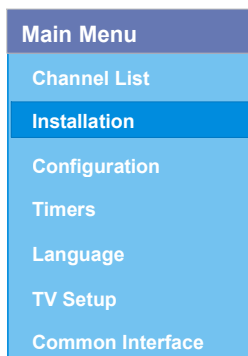

This menu includes the following items:

1. Add New Channels
2. First Time Installation.

ADD NEW CHANNELS:

This tuning menu consists of two parts:

- Automatic Search
- Manual Search



Automatic Search:

Automatic search is started by pressing the “OK” button in the auto-search pop up menu. All the services are searched and a channel table is created automatically.

All channels found are stored in a sorted form with respect to their channel numbers. Some services may not appear with the correct channel number. At the time of printing, not all broadcasters are sending their channel number information.

Manual Search:

In manual search, the number of the multiplex is entered manually and only that multiplex is searched for the channels. For every valid channel number, signal level, signal quality and network name are shown at the bottom of the screen.

In both manual and auto search any existing channel in the database is not re-stored to avoid redundant duplicates of that channel.

FIRST TIME INSTALLATION

The user can use this item to load default settings, which had been loaded to the receiver at the factory.

To install factory settings, highlight “**First Time Installation**” menu and press the “OK” button, then you will be asked to confirm for deleting all channels and settings.

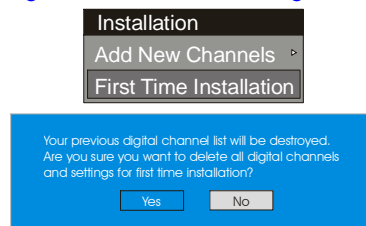

By selecting YES and pressing the “OK” button, the existing channel table will be deleted.

After factory settings is loaded, “**First Time Installation**” menu will be displayed.

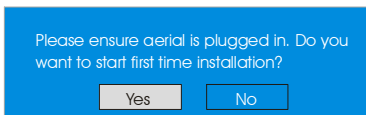

Press the “OK” button to start installation. Af-

ter search is completed for digital channels, a message asking search for analogue channels appears on the screen.

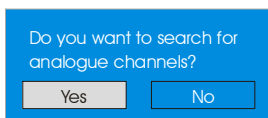

Press the "OK" button to search for analogue channels. The following menu appears on the screen for analogue channel search.

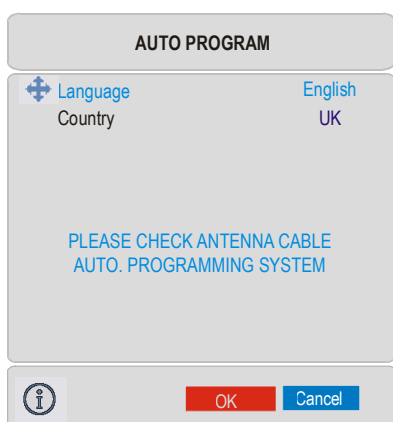

First of all choose Language and Country by using ▲ / ▼ and ◀ / ▶ buttons. This will affect the sort process in APS. To start APS, press the RED or "OK" button.

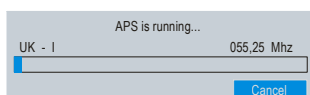

After APS is finalized, the programme table will appear on the screen. In the programme table you will see the programme numbers and names assigned to the programmes.

If you do not accept the locations and / or the programme names, you can change them in the Program menu.

Configuration

Press the "M" button to display the Main Menu and the ▼ button twice to highlight Configuration, then press the "SELECT" button to display the Configuration menu. Press the "M" button to leave the menu.

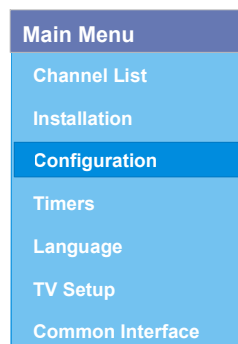

The various configuration functions are displayed in a list, along with a quarter-screen image of the currently selected channel. You can select a function by highlighting the corresponding menu line using the ▲ or ▼ button.

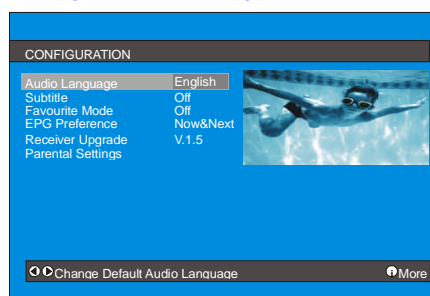

Audio Language

Digital terrestrial television channels can broadcast simultaneous soundtracks in more than one language. This function selects which language soundtrack you will hear when switching to a channel broadcasting with the multiple soundtracks.

Highlight the **Audio Language** line in the Configuration menu and use the ◀ or ▶ button to cycle through the language options.

Subtitle

Digital terrestrial television channels can broadcast subtitles displayed on-screen for the hard-of-hearing. This function selects the desired subtitle language and enables the automatic display of subtitles whenever subtitle information is broadcast.

Highlight the Subtitle line in the Configuration menu and use the ◀ or ▶ button to cycle through "Off" and language options.

Favourite Mode

This function enables or disables the favourite channel list mode. See **Channel List menu Favourites on page 13**.

Use ◀ or ▶ button to turn on/off favourite mode. If the **“Favourite Mode”** is on, in normal operating mode pressing **“P/CH+”** and **“-P/CH”** buttons will only navigate through the channels that were previously defined as favourites in Channel List.

EPG Preference

Digital terrestrial television channels can broadcast simultaneous Next&Now and 7-Day electronic programme.

Highlight the EPG Preference line in the Configuration menu and use the ◀ or ▶ button to select **Next&Now** or **7-Day**.

Receiver Upgrade

The IDTV can be upgraded via the configuration menu, entered from the main menu.

In the Configuration menu, highlight the **“Receiver Upgrade”** item by pressing ▲ or ▼ button and press the **“SELECT”** button to start upgrade process.

There are two possibilities for Receiver software to be upgraded: **automatic** and **manual**.

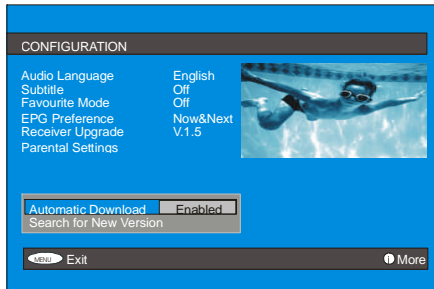

Automatic Download (Automatic upgrade)

Automatic Download can be enabled or disabled by pressing ◀ or ▶ button. If it is enabled, then there are two ways for automatic upgrade. The first one is checking the existence of a new software every time the IDTV goes to standby. The second one is waking up at 03:00 a.m. every night, provided that the IDTV is left in standby mode.

Both automatic upgrade methods result in standby mode either upgraded or not.

If the automatic upgrade is set to **“Disabled”** then this function will not work.

Search For New Version (Manual upgrade)

Manual upgrade starts if the **“Search for New Version”** item is highlighted by using ▲ or ▼ button and activated via pressing the **“SELECT”** button.

After **“Search for New Version”** is activated, the IDTV tunes to each frequency that have been stored in its database and looks for the new software.

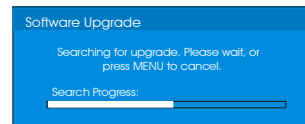

Parental Settings

Some channels broadcast material which you do not want younger members of the family to watch. Any channel can be **‘locked’** so that it cannot be selected for viewing without first a four-digit PIN code being entered. In this way any channel not suitable for younger viewers can be protected.

This function enables or disables the menu protection system and allows the PIN code to be changed.

Use ▲ or ▼ button to go to Parental Settings option. Press the **“SELECT”** button to enter Parental Settings Menu. A box asking for the lock key is displayed.

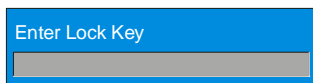

There is only one key which is set to **“0000”** initially. Enter lock key. If wrong Lock key is entered, the following message is displayed on the screen and it is returned back.



If it is correct, the Parental Settings Menu including following items is displayed:

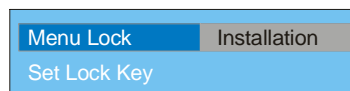

There you can set/reset locking for the Main Menu, or the Installation Menu to restrict access. If the menu lock is disabled, there will be free access to the menu system. Also in this menu you can change the lock key and set/change parental lock mode.

Disabled: All menus are unlocked.

Main Menu: Main menu is accessible only with the correct lock key. So the user cannot add, delete, rename, move channels, cannot set timers.

Installation: Installation menu is locked, so the user cannot add channels.

Changes will be updated after exiting Configuration Menu.

Timers

You can set a timer to switch the TV to any channel without your intervention. This is also for making video recordings of programmes when you are out.

Display the Main Menu by pressing the "M" button. Highlight the **Timers** line by pressing ▲ or ▼ button and press the "SELECT" button to display the Timer menu.

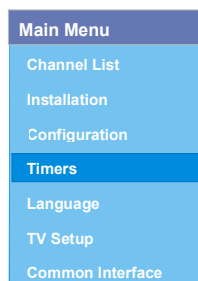

Up to five separate timer events can be set and each is displayed in the Timer screen, showing the event number, the channel to be selected, the start time, end time, date and the mode - whether that event is active (and will be acted on) or not.

No	Channel Name	Start	End	Date	Mode
1.	ITV 1	20:00	21:00	12/05/2005	Active
2.	BBC ONE	00:00	00:00	01/01/2005	Inactive
3.	BBC ONE	00:00	00:00	01/01/2005	Inactive
4.	BBC ONE	00:00	00:00	01/01/2005	Inactive
5.	BBC ONE	00:00	00:00	01/01/2005	Inactive
6.	BBC ONE	00:00	00:00	01/01/2005	Inactive

Navigation: ◀ Toggle Mode ▶ Exit ◀ Edit Timer ▶ More

- To set an event, highlight its mode button using the ▲ or ▼ button and press the "SELECT" button to display the timer entry window.

Name: 3. ITV 1
 Start: 00:00
 End: 00:00
 Date: 03/06/2005
 Mode: Once

- Here the five settings of channel name, start time, end time, date and frequency mode can be set. You can move freely between each setting using the ▲ or ▼ buttons.
- The channel name is set using the ◀ or ▶ button to display the channel which broadcasts the programme.
- The start time, end time and date are each set with the digit buttons on the remote control in 24-hour format.
 - The frequency mode determines how often the receiver operates this event and is set with the ◀ or ▶ button to be either **Once**, **Daily**, or **Weekly**.

If an invalid number for the start or end times or the date is entered, "Entered time is not valid" message appears on the menu.

If timer action occurs while the TV is watched, the TV switches to the selected channel. When timer expires, the TV switches to the channel which it is switched from.

Selected digital channel will be output via Scart-2. You should connect your VCR to Scart-2 for recording digital broadcast.

Language

Some programmes are broadcast in two or more languages simultaneously. The language heard can be selected from the Language Menu.

- Press the “M” button to display the Main Menu and use ▲ or ▼ button to highlight the Language line and press the “SELECT” button.

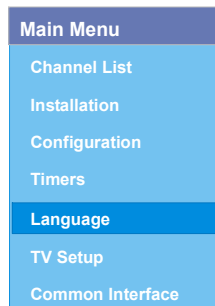

- Use the ▲ or ▼ button to highlight the soundtrack language required and press the “SELECT” button. Normal viewing, with the required language soundtrack, can be resumed by pressing the “M” button.



TV Setup

To be able to go through TV functions, you can use this item.

The digital TV Setup menu screen is accessed from the main menu. Press the “M” button to display the main menu and use ▲ or ▼ button to highlight “TV Setup”, press the “SELECT” button to display TV Setup menu screen.

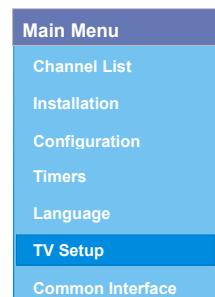

Detailed information about Sound, Picture and Feature menus are in AnalogueTV Menu System section on page 19.

Common Interface

- Press the “M” button to display the Main Menu and use the ▲ or ▼ button to highlight the “Common Interface” line and press the “SELECT” button.

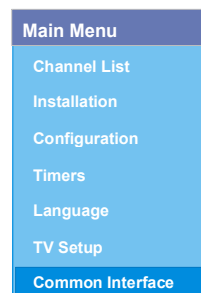

It is required to subscribe to a pay channel company to view the pay channels of the Digital Terrestrial broadcasting.

Obtain the Conditional Access Module (CAM) and the Viewing card by subscribing to a pay channel company, then insert those to the Television using the following procedure.

1. Switch off the TV and unplug from the mains.

2. Insert the CAM, then Viewing Card to the slot that is located in the terminal cover at the left-hand side of the TV (from front view).

- The CAM should be correctly inserted, it is impossible to insert fully if reversed. The CAM or the TV terminal may be damaged if the CAM is forcefully inserted.

3. Connect the TV to the mains supply, switch on and then wait for few moments until the card is activated.

- Some CAMs may require the following set up. Please set the CAM by entering the IDTV menu, Common Interface then pressing the “SELECT” button. (CAM set up menu is not displayed when it is not required.)

- To see the viewing contract information:

Enter IDTV; press the “M” button, then highlight **Common Interface** and press the “SELECT” button.

- When no module is inserted, “**No Common Interface module detected**” message appears on the screen.
- Refer to the module instruction manual for details of the settings.

Analogue TV Menu System

Your TV has been designed with a menu system to provide easy manipulation of a multifunction system.

Press the “**M**” button to enter the menu. Press ◀ / ▶ button to select a menu title and then ▲ / ▼ button to select a menu item and ◀ / ▶ or “**OK**” button to enter the menu item.

You can access the menus directly by pressing the coloured buttons on the remote control:

Red Button	Sound Menu
Green Button	Picture Menu
Yellow Button	Feature Menu
Blue Button	Install Menu

- Press the “**M**” or  button to return to the previous menu.

Picture menu

By pressing ◀ / ▶ button, select the first icon. Picture menu appears on the screen.

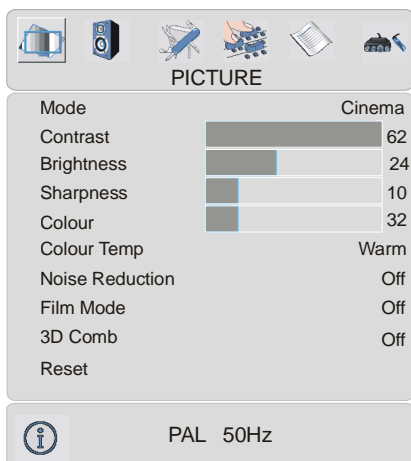

Mode

By pressing ▲ / ▼ button, select **Mode**. Press ◀ / ▶ button to choose one of these options: **Natural**, **Cinema** and **Dynamic**.

Contrast

By pressing ▲ / ▼ button, select **Contrast**. Press ▶ button to increase contrast. Press ◀ button to decrease contrast. Contrast level can be adjusted between 0 and 63.

Brightness

By pressing ▲ / ▼ button, select **Brightness**. Press ▶ button to increase brightness. Press ◀ button to decrease brightness. Brightness level can be adjusted between 0 and 63.

Sharpness

By pressing ▲ / ▼ button, select **Sharpness**. Press ▶ button to increase sharpness. Press ◀ button to decrease sharpness. Sharpness level can be adjusted between 0 and 31.

Colour

By pressing ▲ / ▼ button, select **Colour**. Press ▶ button to increase colour. Press ◀ button to decrease colour. Colour level can be adjusted between 0 and 99.

Hue

This item is displayed in picture menu when the TV receives an NTSC signal. By pressing ▲ / ▼ button, select **Hue**. Press ▶ button to increase hue level. Press ◀ button to decrease hue level. Hue level can be adjusted between -31 and 31.

Colour Temp

By pressing ▲ / ▼ button, select **Colour Temp**. Press ◀ / ▶ button to choose one of these options: **Cool**, **Normal** and **Warm**.

Noise Reduction

This item is used to reduce the image noise and improve the picture quality at weak signals.

By pressing ▲ / ▼ button, select **Noise Reduction**. Press ◀ / ▶ button to set **Noise reduction** level to **Off**, **Low**, **Medium** or **High**.

Film Mode

Films are recorded at a different number of frames per second to normal television programmes.

By pressing ▲ / ▼ button, select **Film Mode**. Press ◀ / ▶ button to set this feature On or Off. Turn this feature on when you are watching films to see the fast motion scenes clearly.

3D Comb

3D Comb is used to improve colour transitions and colour quality of pictures.

By pressing ▲ / ▼ button, select **3D Comb**. Press ◀ / ▶ button to set this feature On or Off.

Reset

By pressing ▲ / ▼ button, select **Reset**. Press ◀ / ▶ or "OK" button to reset the picture modes to factory default settings.

Sound menu

By pressing ◀ / ▶ button, select the second icon. Sound menu appears on the screen.

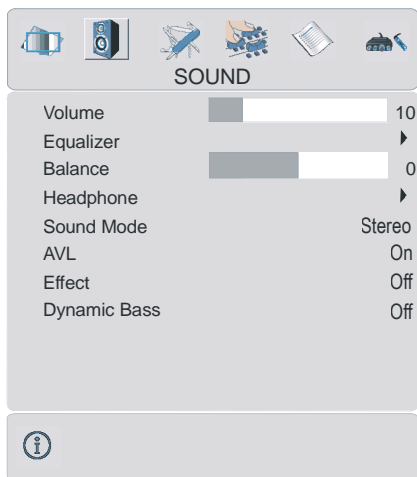

Volume

By pressing ▲ / ▼ button, select **Volume**. Press ▶ button to increase volume level. Press ◀ button to decrease volume level. Volume level can be adjusted between 0 and 63.

Equalizer

By pressing ▲ / ▼ button, select **Equalizer**. Press ◀ / ▶ or "OK" button to enter equalizer menu.

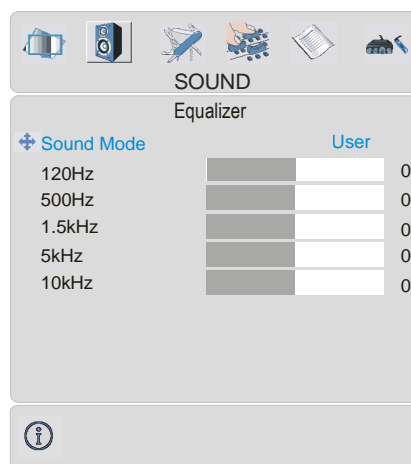

In equalizer menu the sound mode can be changed to **User, Pop, Rock, Jazz, Flat** and **Classic** by pressing ◀ / ▶ button. Equalizer menu settings can be changed only when **Sound Mode** is **User**. Select the desired frequency by ▲ / ▼ button and increase or decrease the frequency gain by pressing ◀ / ▶ button.

Press the "M" button to return to the previous menu.

Balance

By pressing ▲ / ▼ button, select **Balance**. Press ▶ button to increase balance to the right. Press ◀ button to increase balance to the left. Balance level can be adjusted between -31 and 31.

Headphone

By pressing ▲ / ▼ button, select **Headphone**. Press ◀ / ▶ or "OK" button to enter headphone menu.

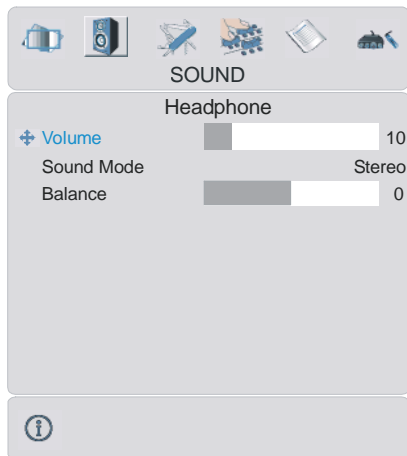

volume

By pressing ▲ / ▼ button, select **Volume**. Press ► button to increase hp volume level. Press ◀ button to decrease hp volume level. Headphone volume level can be adjusted between 0 and 63.

sound mode

By pressing ▲ / ▼ button, select **Sound Mode**. Press ◀/► button to change sound mode. Sound mode is used to identify sound mode of the headphone and can be set to **mono**, **stereo**, **dual a** or **dual b** according to the transmission.

balance

By pressing ▲ / ▼ button, select **Balance**. Press ► button to increase balance to the right. Press ◀ button to decrease balance to the left. Balance level can be adjusted between -31 and 31.

Press the “M” button to return to the previous menu.

Sound Mode

By pressing ▲ / ▼ button, select **Sound Mode**. Press ◀/► button to change the mode.

You can select **Mono**, **Stereo**, **Dual A** or **Dual B** mode, only if the selected channel supports that mode.

In case of bilingual broadcast (Dual Sound), you can select original or dubbed language using mode option.

AVL

Automatic Volume Limiting (AVL) function adjusts the sound to obtain fixed output level between programs, having different sound levels.

Pressing ◀/► button will turn this feature on or off.

Effect

You can use this feature to switch the sound effect on or off. If the current sound system is Mono and the sound effect is switched on, then the sound will be heard as if it is Stereo. If the current sound system is Stereo, switching this effect on will give a more spatial effect.

Pressing ◀/► button will turn this feature on or off.

Dynamic Bass

Dynamic Bass is used to increase bass effect of the TV set.

By pressing ▲ / ▼ button, select **Dynamic Bass**. By pressing ◀/► button set Dynamic bass to Low, High or Off. It is not recommended to select High if listening at high volume levels.

Feature menu

By pressing ◀/► button, select the third icon. Feature menu appears on the screen.

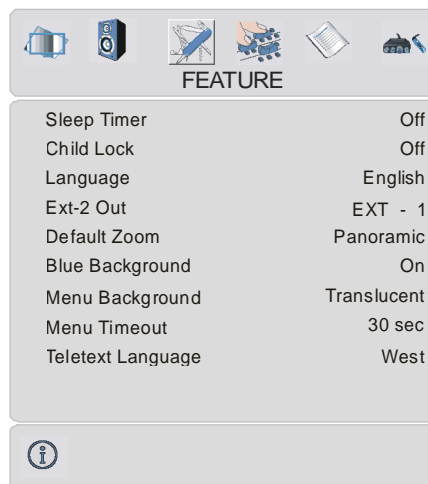

Sleep Timer

By pressing ▲ / ▼ button, select **Sleep Timer**. The timer can be programmed between Off and 2 hours in steps of 10 minutes by pressing ◀ / ▶ button. If sleep timer is activated, at the end of the selected time, the TV automatically goes into stand-by mode.

Child Lock

You can use this feature to prevent children from turning the TV on or changing programmes or adjustments etc. without remote control.

The child lock feature can be set by ◀ / ▶ button to either **On** or **Off**. When **Off** is selected, there will be no difference in the operation of your TV. When **On** is selected, the TV can only be controlled by the remote control handset. In this case the control panel buttons, except the Power on/off button, at the rear side of the TV will not work. If one of these buttons is pressed, "Child Lock On" will be displayed on the screen.

Language

By pressing ▲ / ▼ button, select **Language**. By pressing ◀ / ▶ button, you can select the language.

Ext-2 Out

By pressing ▲ / ▼ button, select **Ext-2 Out**. You can set **Ext-2 Out** to **TV**, **EXT-1**, **EXT-3**, **EXT-4** or **EXT-5** by pressing ◀ / ▶ button.

Note: Only audio output is available for EXT-3 and EXT-5. The other options have both audio and video outputs.

Default Zoom

By pressing ▲ / ▼ button, select **Default Zoom**. You can set **Default Zoom** to **Panoramic**, **4:3** or **14:9 Zoom** by pressing ◀ / ▶ button.

If there is no WSS or aspect ratio (picture size) information and zoom mode is selected as **Auto** by pressing the "WIDE" button, then the zoom mode will automatically change to Default Zoom setting. See also Zoom Modes on page 17.

Blue Background

You can set the TV to automatically change to a blue screen if the signal is weak or absent, or when there is no input from an external device.

The **Blue Background** feature can be turned on or off by pressing ◀ / ▶ button.

Menu Background

By pressing ▲ / ▼ button, select **Menu Background**. You can change menu background to **Translucent** or **Opaque** by pressing ◀ / ▶ button.

Menu Timeout

By pressing ▲ / ▼ button, select **Menu Timeout**. Press ◀ / ▶ button to change menu timeout to **15 sec**, **30 sec** or **60 sec**.

Teletext Language

By pressing ▲ / ▼ button, select **Teletext Language**. Press ◀ / ▶ button to change Teletext Language to **West**, **East**, **Cyrillic**, **Turk/Gre** or **Arabic**. This will normally be set to West for Western Europe.

Install menu

By pressing ◀ / ▶ button, select the fourth icon. Install menu appears on the screen.

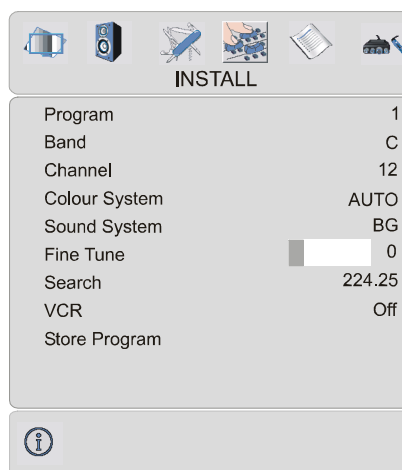

Program

By pressing ▲ / ▼ button, select **Program**. Press ◀ / ▶ button to select the program number. You can also enter a number via digit buttons on the remote control. There are 100 program storage between 0 and 99.

Band

Band can be selected either "C" or "S" using the ▶ / ◀ buttons. "C" is used for "Off Air" signals. "S" is used for cable connections.

Channel

Channel can be changed by ◀ / ▶ button or Digit Buttons.

Colour System

By pressing ▲ / ▼ button, select **Colour System**. Press ◀ / ▶ button to change the colour system to **PAL**, **SECAM**, **PAL60** or **AUTO**.

If Sound System is set to **I**, **SECAM** is not available for the Colour System.

Note: In EXT mode, you can choose NTSC 3.58 and NTSC 4.43 as well.

Sound System

By pressing the ▲ / ▼ buttons, select **Sound System**. Press the ◀ / ▶ buttons to select the Sound system. BG "Western Europe", DK "Eastern Europe", I "UK only" L and LP "France".

Fine Tune

By pressing ▲ / ▼ button, select **Fine Tune**. Press ◀ / ▶ button to adjust the tuning.

Search

By pressing ▲ / ▼ button, select **Search**. Press ◀ / ▶ button to start program searching. The searching will stop when a signal is found. You can also enter a frequency value directly by pressing the digit buttons.

VCR (Video Cassette Recorder)

- This item can be seen in **all modes except EXT-3 and EXT-5**.
- If you want to watch a **VCR** source from one of these modes, then it will be better to set

VCR mode "on". For this, while the cursor is on this item press the ◀ / ▶ buttons to set it "On".

- If you want to watch a **DVD**, then you must set this item "Off".

Store Program

By pressing ▲ / ▼ button, select **Store Program**. Press ◀ / ▶ or "OK" button to store the adjustments. "Program Stored" will be displayed on the screen.

Program menu

By pressing ◀ / ▶ button, select the fifth icon. Program menu appears on the screen.

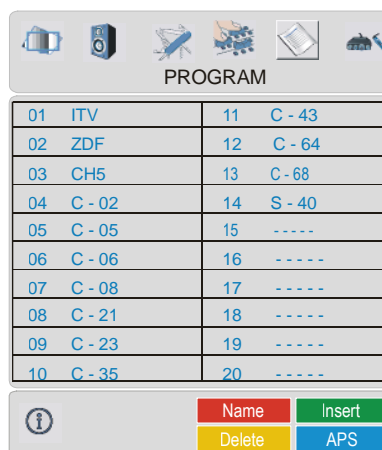

By moving the cursor in four directions you can reach 20 programmes in the same page. You can scroll the pages up or down by pressing the navigation buttons to see all the programmes in TV mode (except the AV mode).

By cursor action, programme selection is done automatically.

Name:

To change the name of a decided programme, select the programme and press the RED button.

The first letter of the selected name starts to blink. Press ▲ / ▼ button to change that letter and ◀ / ▶ button to select the other letters. By pressing the RED button, you can store the name.

Insert:

Select the programme which you want to insert by navigation buttons. Press the GREEN button. By navigation buttons move the selected programme to the decided programme space and press the GREEN button again.

Delete:

To delete a programme, press the YELLOW button. Pressing the YELLOW button again erases the selected programme from the programme list, and the programmes below shift one up.

APS (Automatic Programming System)

When you press the BLUE button for APS, the following warning screen will be displayed.

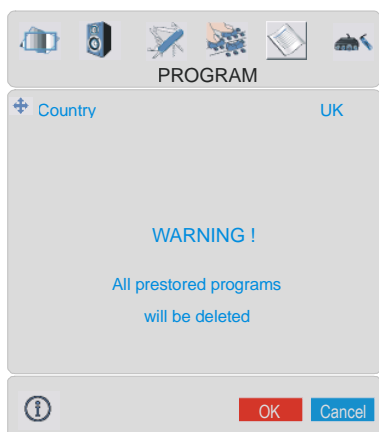

Press the BLUE button to cancel APS if you do not want to delete your existing programme list.

To continue APS, first select the country by pressing ◀ / ▶ button and then press the RED or "OK" button.

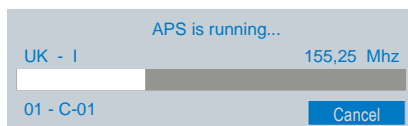

After APS is finalized, the programme table will appear on the screen.

Source menu

By pressing ◀ / ▶ button, select the sixth icon. Source menu appears on the screen.

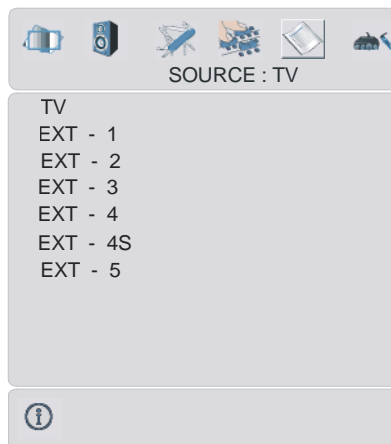

In source menu, highlight a source by pressing ▲ / ▼ button and switch to that mode by pressing ◀ / ▶ or "OK" button.

Other Features

TV Status

Programme Number, Programme Name, Sound Indicator and **Zoom Mode** are displayed on the upper right side of the screen when a new programme is entered,  button is pressed.

Mute Indicator

It is placed in the upper left side of the screen when enabled.



To cancel mute, there are two alternatives; the first one is pressing the  button and the second one is increasing/decreasing the volume level.

Freeze Picture

You can freeze the picture on the screen by pressing the **OK** button.

Zoom Modes

Zoom mode can be changed by pressing the **WIDE** button. You can change the screen size according to the picture aspect ratio. Select the optimum one from the following **ZOOM** modes.

Auto:

When a **WSS (Wide Screen Signalling)** signal, which shows the aspect ratio of the picture, is included in the broadcast signal or the signal from an external device, the TV automatically changes the **ZOOM** mode according to the **WSS** signal.

- When the **AUTO** mode does not function correctly due to poor **WSS** signal quality or when you want to change the **ZOOM** mode, change to another **ZOOM** mode manually.

Full:

This uniformly stretches the left and right sides of a normal picture (4:3 aspect ratio) to fill the wide TV screen.

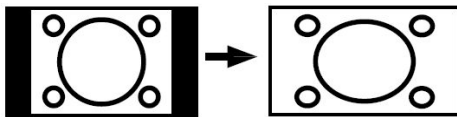

- For 16:9 aspect ratio pictures that have been squeezed into a normal picture (4:3 aspect ratio), use the **Full** mode to restore the picture to its original shape.

Cinema:

This zooms up the wide picture (16:9 aspect ratio) to the full screen.

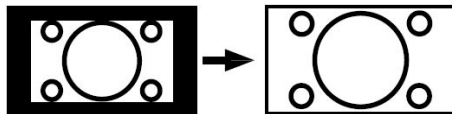

16:9 Subtitle:

This zooms up the wide picture (16:9 aspect ratio) with subtitles to the full screen.

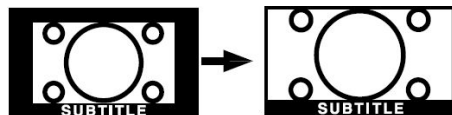

“Default Zoom” Modes:

4:3

Use to view a normal picture (4:3 aspect ratio) as this is its original shape.

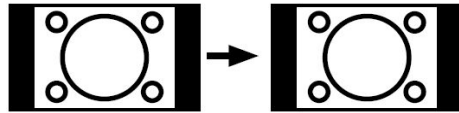

14:9 Zoom:

This zooms up the wide picture (14:9 aspect ratio) to the upper and lower limits of the screen.

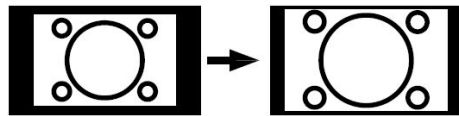

Panoramic:

This stretches the left and right sides of a normal picture (4:3 aspect ratio) to fill the screen, without making the picture appear unnatural.

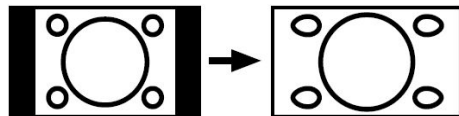

The top and bottom of the picture are slightly cut off.

Teletext

Teletext is an information system that displays text on your TV screen. Using the Teletext information system you can view a page of information on a subject that is available in the list of contents (index).

To Operate Teletext

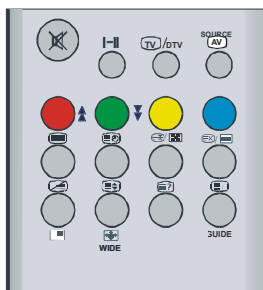

- Select a TV station where Teletext is being transmitted.
- Press the  button. Usually the list of contents (index) is displayed on the screen.



To Select A Page Of Teletext

- Press the appropriate digit buttons for the required Teletext page number.



The selected page number is displayed in the top left corner of the screen. The Teletext page counter searches until the selected page number is located, the desired page is then displayed on the screen.

- Press the  or "P +" button to move the Teletext screen forward one page at a time.
- Press the  or "P -" button to move the Teletext screen backward one page at a time.



To Select Index Page

- To select the page number of the index (generally page 100), press the  button.



To Select Teletext With A TV Programme

- Press the  button. The text is now superimposed over the programme on the screen.
- Press the  button again to return to the Teletext page.

To Select Double Height Text



- Press the  button for the top half of the information page to be displayed in double height text.
- Press the  button again for the bottom half of the information page to be displayed in double height text.
- Press the  button once more for the full page of normal height text.

To Reveal "Concealed" Information

- Pressing the  button once will reveal answers on a quiz or games page.
- Pressing the  button again will conceal the revealed answers.



To Stop Automatic Page Change

The teletext page you have selected may contain more information than what is on the screen; the rest of the information will be displayed after a period of time.

- Press the  button to stop the automatic page change.
- Press the  button again to allow the next page to be displayed.

To Select A Subcode Page

Subcode pages are subsections of long Teletext pages that can only be displayed on the screen one section at a time.

- Select the required Teletext page.
- Press the  button.
- Select the required subcode page number by pressing four digit buttons (e.g. 0001).
- If the selected subcode page is not displayed in a short time, press the  button. TV programme will be displayed on the screen.
- Teletext page number will be displayed on the upper left corner of the screen when the selected page is found.
- Press the  button to display the selected Teletext page.

To Exit Teletext



- Press the  button. The screen will switch to TV mode.

To Display The Time

- While watching a TV programme with Teletext transmission press the  button. The current time information, captured from Teletext will be displayed on the screen.
- If the programme being watched does not have Teletext transmission, no information will be displayed.

Fasttext

Your TV supports the 1000 page Teletext system. When the page number of any of the 1000 pages in memory is entered, the system will not search for the requested page; instead it will display the page automatically. If the requested page is not in memory, the system will search for the requested page number and save the 1000 pages including the requested page into memory after finding it.

- Press the  button to move the Teletext screen forward one page at a time.
- Press the  button to move the Teletext screen backward one page at a time.

For Fasttext

The subject-heading for the information may have a particular colour.



- Press an appropriate **RED, GREEN, YELLOW** or **BLUE** button in order to reach the relevant page quickly.

For TOP text

TOP text mode of operation will be activated automatically according to the transmission.

- If TOP text transmission is present, colour coded buttons will appear in status row.
- If TOP text transmission is not present, status row will not appear.

The subject-heading for information may be located in coloured box.

In Top mode the  or  commands will request the next or previous page respectively.

If TOP text transmission is not available, in case of operation of these commands, wraparound occurs. For example page 100 appears to be one greater than page 199.

Connect Peripheral Equipment

There is a wide range of audio and video equipment that can be connected to your TV.

The following connection diagrams show you where the different (Optional) equipment should be connected at the rear side of the TV.

High Definition

Your **LCD Television** is capable of displaying High Definition pictures from devices such as a High Definition Satellite Receiver or DVD Player. These devices must be connected via the HDMI socket (**EXT-5**) or Component Socket (**EXT-3**). These sockets can accept either 720p or 1080i signals.

Note: For proper connection of a device to HDMI input of your TV via using a DVI-to-HDMI cable, use PC Audio In input for sound connection.

Via The Scart

LCD TV has 2 Scart sockets. If you want to connect peripherals (e.g. video, decoder, etc.) which have Scart sockets to the TV, use SCART 1 or SCART 2.

If an external device is connected via the Scart sockets, the TV will be switched to AV mode automatically.

- Do not connect Digital Set Top Box devices via Scart 1. Use Scart 2.

Via Aerial Input

If you want to connect to your TV, peripherals like video recorders or decoders, but the device you want to connect does not have a Scart socket, you should connect it to the Aerial input of the TV.

If the VCR is connected via Aerial input it is suggested to use Programme 0.

Decoder

Cable TV offers you a wide choice of programmes. Most of them are free, others are to be paid for by the viewer. This means that you will need to subscribe to the broadcasting organisation whose programmes you wish to receive. This organisation will supply you a corresponding decoder unit to allow the programmes to be unscrambled.

For further information ask your dealer. See also the booklet supplied with your decoder.

Connect a decoder with an aerial socket to the TV

- Connect the aerial cable.

Connect a decoder without an aerial socket to the TV

- Connect the decoder to the TV with a Scart cable to **SCART 1**.

TV And Video Recorder

- Connect the aerial cables.

Better picture quality can be obtained if you also connect a Scart cable to **SCART** sockets.

Playback NTSC

To use this option you can;

- Connect an NTSC VCR player to a Scart socket at the rear side of the TV.
- [Connect an NTSC VCR player to RCA Jacks at the side of the TV.](#)

Then, press **AV** button to select appropriate source.

Copy Facility

Source selection for **VCR** recording.

- Select **Feature** menu.
- Select **Ext-2 Out** by pressing **◀/▶** button.
- Select a source to copy the picture from that source.

Search For And Store The Test Signal Of The Video Recorder

- Unplug the aerial cable from the aerial socket of your video recorder.
- Switch on your TV and put the video recorder on the test signal. (See the booklet for your video recorder.)

- Enter the **Install** menu and select **search**.
- Search for the test signal of your video recorder in the same way as you searched for and stored the TV signals. Store the test signal under programme number 0.
- Replace the aerial cable in the aerial socket of your video recorder once you have stored the test signal.

Camera And Camcorder

To Connect To AV Input

Connect your camera or camcorder to AV (EXT-4) input at the [right](#) side of the TV.

- Connect your equipment to the TV via **VIDEO** (yellow), **AUDIO R** (red) and **AUDIO L** (white) inputs. You must connect the jacks to the input using the same colour.

To Connect To S-Video Input

[Connect your camera or camcorder to the S-VIDEO input \(EXT-4S\) on the right side of the Tv.](#)

- [Connect your equipment to the Tv via the S-VIDEO input. Connect Audio inputs using the RCA \(Phono\) leads](#)

Connect The Decoder To The Video Recorder

Some video recorders have a special Scart socket for decoder.

- Connect a Scart cable to the Scart socket of your decoder and to the special Scart socket of your video recorder. Refer to the booklet of your video recorder.
- To connect your video recorder to the TV, refer to the TV and Video Recorder section.

If you want to connect more equipment to your TV, consult your dealer.

Connecting Headphones

Use the stereo headphone socket at the [right](#) side of the TV, to connect headphones.

Aerial Connection

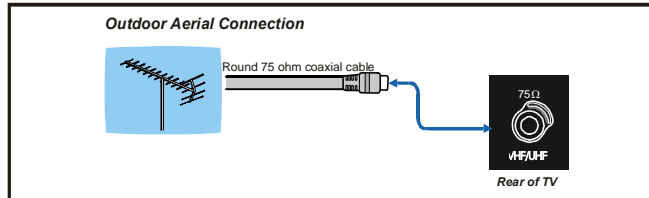

Connect Peripheral Equipment

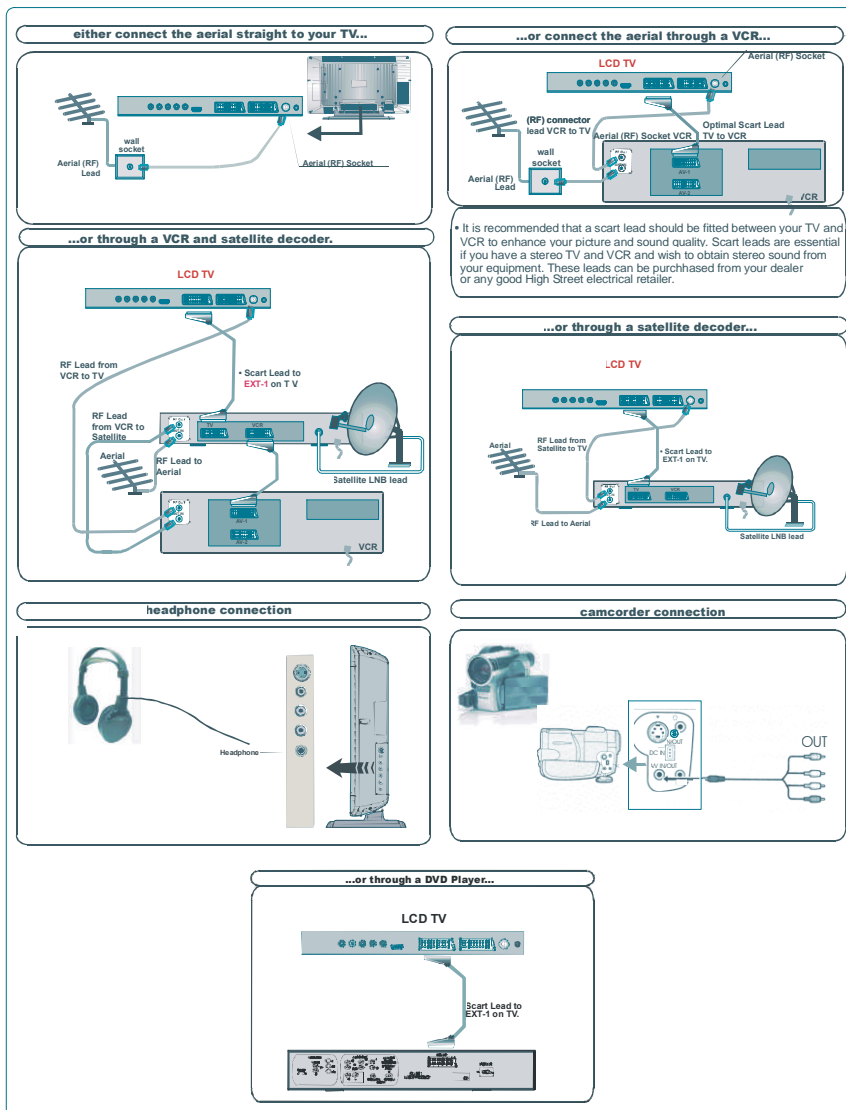

Trouble Shooting Guide

Should you have any trouble installing the Tv, please consult the guide below before calling the Technical Help Line below

SYMPTOM	POSSIBLE CAUSE	REMEDY
Set Dead No Led lit	Power not connected to the Tv	Ensure the power lead is firmly fitted and the tv is switched on
Set dead Standby Led lit Red	Tv is in Standby mode	See page 6
No picture. Standby led Green	Set switched to Av mode with no input	Select TV or DVB or switch AV source on.
Poor noisy or Ghosting picture. Analog	Poor aerial signal	Check all aerial connections. If using an indoor aerial have an Disconnect other items using the same aerial
Picture freezing or breaking up in IDTV mode	Poor aerial signal	Check all aerial connectors. Digital Tv requires a good signal. Indoor aerials are rarely suitable
No sound	Mute turned on.	Turn mute "off"
	If in HDTV mode	Connect sound input via PC sound input connector
Teletext poor (analog)	Poor aerial signal	See above

If you are still having difficulty please call the Technical help line. Ring 01422 203676 (Normal rates apply).

Opening hours Mon-Fri 8 am – 8pm. Sat 9 am – 4pm. Sun 11am – 4pm "Bank holidays as Sun"

Care of the Screen

Clean the screen with a slightly damp, soft cloth. Do not use abrasive solvents as they may damage the TV screen coating layer.

Specifications

TV BROADCASTING

PAL/SECAM B/G D/K K' I/I' L/L'

RECEIVING CHANNELS

VHF (BAND I/III)
UHF (BAND U)
HYPERBAND
CABLE TV (S1-S20/ S21-S41)

NUMBER OF PRESET CHANNELS 100

CHANNEL INDICATOR

On Screen Display

RF AERIAL INPUT

75 Ohm (unbalanced)

OPERATING VOLTAGE

230-240V AC, 50 Hz.

AUDIO

NICAM Stereo

AUDIO OUTPUT POWER ($W_{RMS.}$) (%10 THD)

2 x 8

POWER CONSUMPTION (W)

180 W

3 W (Stand-by)

PANEL

16:9 display, 32" Screen Size

DIMENSIONS (mm)

DIMENSIONS (mm)				
D	L	H	Weight (kg)	
227	922	562	15,0	With foot
105	922	515	13,4	Without foot

CAUTION



The lightning flash with arrowhead symbol, within an equilateral triangle, is intended to alert the user to the presence of un-insulated "dangerous voltage" within the products enclosure that may be of sufficient magnitude to constitute a risk of electric shock to the persons.



The exclamation point within an equilateral triangle is intend to alert the user to the presence of important operating and maintenance (servicing) instructions in the literature accompanying the appliance.

Correct disposal of this Product

(Waste Electrical & Electronic Equipment (WEEE))

The crossed out "Wheelie bin" is intended to show that this appliance must not be placed with ordinary household waste at the end of its useful life. To prevent possible harm to the environment or human health from uncontrolled waste disposal, please keep separate from other household waste and recycle it responsibly to promote the sustainable reuse of material resources.



Household users should contact either the retailer where you purchased the product, or their local government office for details of where and how you can take this item for environmentally safe re-cycling.

Business users should contact their supplier and check the terms and conditions of the purchase contract. This product must not be mixed with other commercial wastes for disposal.

Important Instruction

For your own safety read following instruction carefully before attempting to connect this unit to the mains supply.

MAINS (AC) OPERATION

The wires in the mains lead are coloured in accordance with the following code :

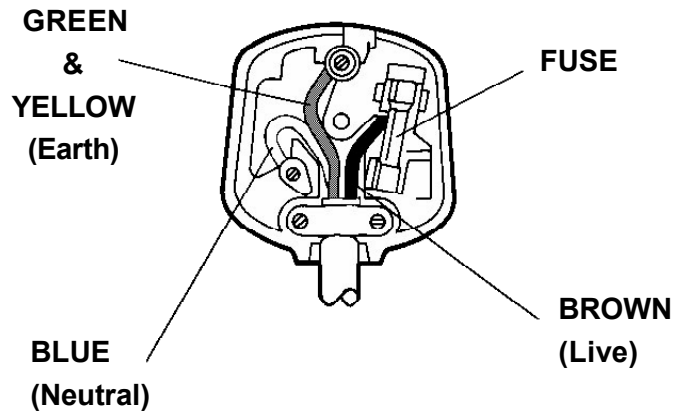

IMPORTANT

For your safety, if the mains plug needs replacing, proceed as follows :-

Connect the Green/Yellow wire to the Centre Pin (EARTH).

Connect the Blue wire to the (N) terminal (this may be coloured blue).

Connect the Brown wire to the (L) terminal adjacent to the fuse (this may be coloured brown).

This appliance must have a 5A fuse fitted.

CAUTION

TO PREVENT ELECTRIC SHOCK DISCONNECT FROM THE MAINS BEFORE REMOVING COVER. NO USER SERVICEABLE PARTS INSIDE. REFER SERVICING TO QUALIFIED SERVICE PERSONNEL.

SAFETY PRECAUTION

THIS EQUIPMENT MUST BE DISCONNECTED FROM THE MAINS WHEN NOT IN USE. DO NOT ALLOW THIS UNIT TO BE EXPOSED TO RAIN OR MOISTURE.