

OPERATING INSTRUCTIONS

AV32751-HD

32" LCD TV COLOUR TELEVISION



Customer Help Line: 01422 263313

Opening Hours: Mon-Fri 8am-8pm, Sat 9am-4pm, Sun 11am-4pm

Or visit our website at www.ekey.co.uk

Contents

Installation Of The TFT TV To The Wall	1
Remote Control Buttons	2
LCD TV	2
Preparation	3
Safety Precautions	3
Before Switching On Your TV	5
Switching The TV ON/OFF	5
Navigating the Menu System	6
Menu System	6
Other Features	10
Teletext	11
Connect Peripheral Equipment	12
Tips	13
Appendix A: Aerial Connection	14
Appendix B: Connect Peripheral Equipment	14
User Help Guide	15
Peripheral Equipment Connections	16
Important Instruction	17
Specifications	18

Installation Of The TFT TV To The Wall

1- To install the TFT TV on the wall, first of all, foot assembly should be removed. (Figure 1). Unscrew the 6 screws (M4 x 16) that attach the foot assembly to the TFT panel and remove the foot assembly from the TFT panel.

2- Place the 4 plastic pins to the circular screw holes at the rear of the TFT and screw them to the TFT panel with 4 (4 x 10) screws.

3- Decide the place on the wall where the TFT panel would be placed. Fix the **stencil wall mount** (shown in Figure 2) on the wall.

The stencil wall mount is used for placing the wall hangers on the wall, properly.

4- Level and mark with a pencil the 4 mounting points on each wall hanger.

Drill pilot holes for the plastic anchors and then fix the wall hangers with 8 screws (4 x 30).

5- Raise the TFT panel and hang it to the holes on the wall hanger from the 4 hanging screws at the rear of the TFT panel.

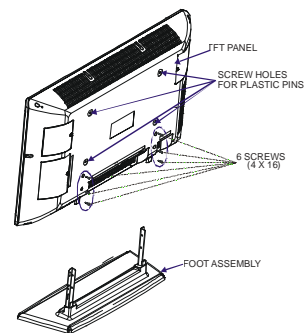
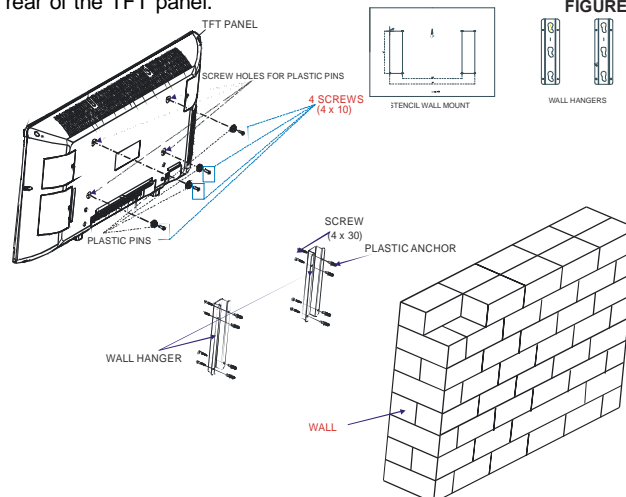
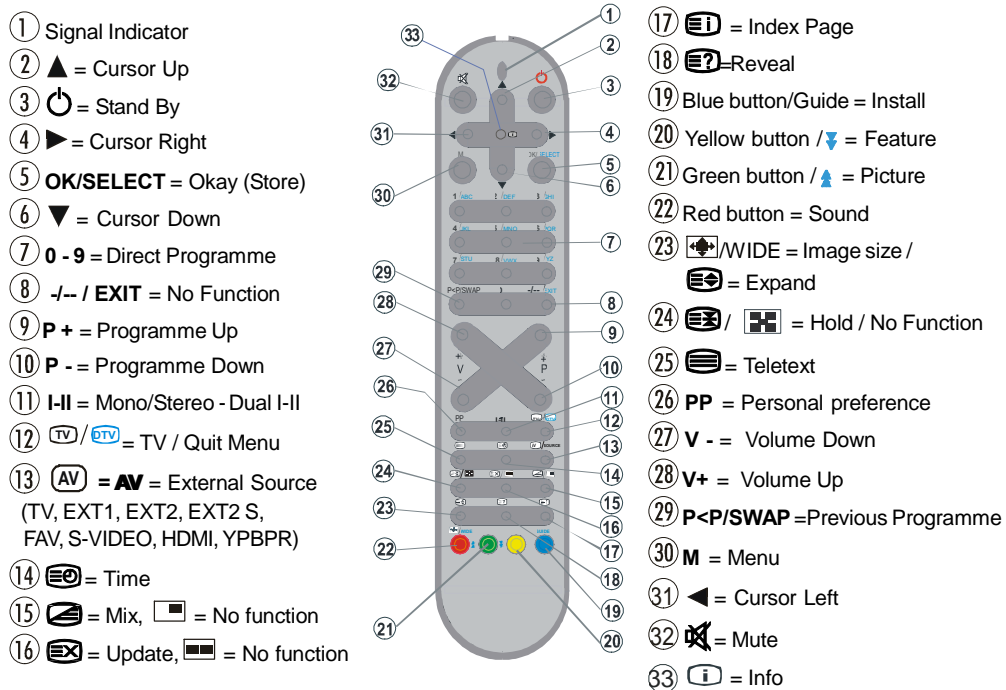

FIGURE 1



Remote Control Buttons



LCD TV

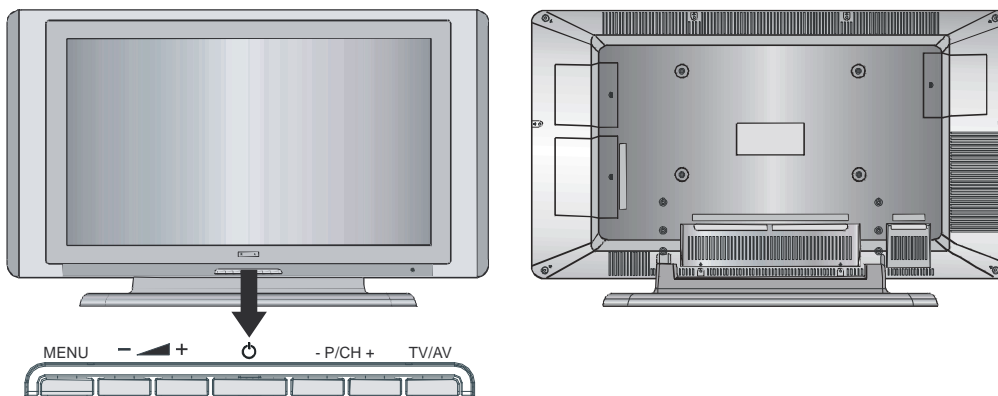

Preparation

For ventilation, leave a space of at least 10 cm free all around the set. To prevent any fault and unsafe situations, please do not place any objects on top of the set.

Use this apparatus in moderate climates.

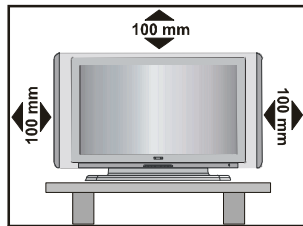

Features

- Remote controlled colour LCD TV.
- 100 programmes from VHF, UHF bands or cable channels can be preset.
- It can tune cable channels.
- Controlling the TV is very easy by its menu driven system.
- It has 2 Scart sockets for external devices (such as video, video games, audio set, etc.)
- Stereo sound system (German+Nicam).
- Full function Teletext (500 pages).
Fastext, TOP text.
- Headphone connection.
- A.P.S. (Automatic Programming System).
- All programmes can be named.
- Forward or backward automatic tuning.
- Sleep timer.
- Child Lock.
- Automatic sound mute when no transmission.
- NTSC Playback.
- AV in and S-VHS in are available.
- It has an HDMI connector for Digital Video and Audio.
This connection is also designed to accept High Definition signals.
- AVL (Automatic Volume Limiting)
- When no valid signal is detected, after 5 minutes the TV switches itself automatically to stand-by mode.
- PLL (Frequency Search)

Safety Precautions

Please read the following recommended safety precautions carefully for your safety

1. Power Source

The set should be operated only from a 230-240V 50 Hz supply.

2. Power Cord

Do not place the set, a piece of furniture, etc. on the power cord (mains lead) or pinch the cord. Handle the power cord by the plug. Do not pull out the plug by tugging the cord and never touch the power cord when your hands are wet as this could cause a short circuit or electric shock. Never make a knot in the cord or tie it with other cord. The power cord should be placed in such a way that they are not likely to be stepped on.

A damaged power cord can cause fire or give you an electric shock. When it is damaged and need to be changed, it should be done by qualified personnel.

3. Moisture and Water

Do not use this equipment in a humid and damp place (avoid the bathroom, the sink in the kitchen, and near the washing machine). Do not expose this equipment to rain or water, as this may be dangerous and do not place objects filled with liquids, such as flower vases on top of the set. Avoid from dripping or splashing.

If any solid object or liquid falls into the cabinet, unplug the set and have it checked by qualified personnel before operating it any further

4. Cleaning

Before cleaning, unplug the set from the wall outlet. Do not use liquid or aerosol cleaners. Use soft and dry cloth.

5. Ventilation

The slots and openings on the back cover are intended for ventilation and to ensure reliable operation. To prevent overheating, these openings must not be blocked or covered in anyway.

6. Heat and Flames

The set should not be placed near to naked flames and sources of intense heat, such as an electric heater. Ensure that no naked flame sources, such as lighted candles, are placed on top of the set

7. Lightning

In the event of a Thunderstorm or when going on holiday, disconnect the mains supply and aerial (if external).

8. Replacement Part

When replacement parts are required, be sure the service technician has used replacement parts which are specified by the manufacturer or have the same specifications as the original one. Unauthorised substitutions may result in fire, electrical shock, or other hazards.

9. Servicing

Please refer all servicing to qualified personnel. Do not remove the cover yourself as this may result in an electric shock.

WARNING: When the device is not in use for a long time, disconnect from power.

Instructions for waste disposal:

- Packaging and packaging aids are recyclable and should principally be recycled. Packaging materials, such as foil bag, must be kept away from children.
- Batteries. These should not be placed in the domestic waste. Do NOT break open or throw on a fire. For disposal contact your local waste authority
- Cold cathode fluorescent lamp in LCD PANEL contains a small amount of mercury, please follow local ordinances or regulations for disposal.
- The mains plug is used to disconnect the TV from the mains and therefore it shall remain readily operable.

Warning: To prevent injury, this device must be securely attached to the floor/wall in accordance with the installation instructions.

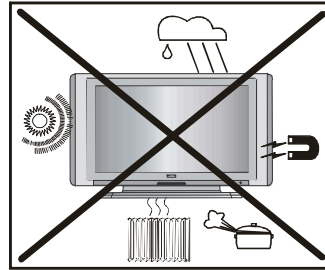

"The LCD panel is very high technology product with about a million thin film transistors, giving you fine picture details. Occasionally, a few non-active pixels may appear on the screen as a fixed point of blue, green or red. Please note that this does not affect the performance of your product."

"DO NOT LEAVE YOUR TV IN STANDBY OR OPERATING WHEN YOU LEAVE YOUR HOUSE"

This is a "Class One" apparatus. Always ensure the earth terminal is connected.

If replacing the mains plug or lead ensure the Earth wire is connected.

If you are not sure please consult your local engineer.



Surely connect the ground wire.

Before Switching On Your TV

Power Connection

IMPORTANT: The TV set is designed to operate on **230-240V AC, 50 Hz.**

- After unpacking, allow the TV set to reach the ambient room temperature before you connect the set to the mains.

Connections To The Aerial Input Socket

- Connect the aerial or cable Tv plug to the Aerial input socket located at the rear of the Tv. A VCR or other box may also be connected.

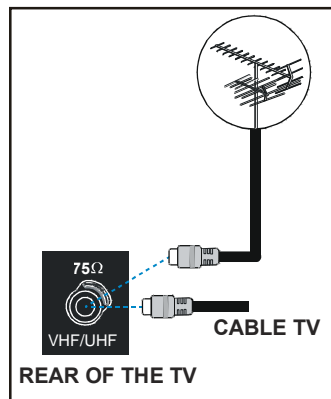

Inserting Batteries In The Remote Control Handset

WARNING : Remote control is battery included. A plastic protector is used to disconnect the batteries in order to prevent the battery life from reducing. Please remove the plastic protector before the first use.

- Remove the battery cover located on the back of the handset by gently pulling backwards from the indicated part.
- Insert two **AAA/R03** or equivalent type batteries inside. Place the batteries in the right directions and replace the battery cover.

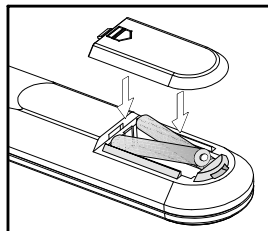

Note: Remove the battery from remote control handset when it is not to be used for a long period. Otherwise it can be damaged due to any leakage of battery.

Switching The TV ON/OFF

To switch the TV on:

Your TV will switch on in two steps:

1. Connect the power supply cord to the Tv. Press the Power ON/Off button located at the REAR of the Tv. The Tv will now be in STANDBY mode.

2. To switch the Tv from Standby mode either :

Press a digit button on the remote control so that a programme number is selected, or Press the “-P/CH” or “P/CH+” button on the TV or press the “-P” or “P+” button on the remote control, so that last mode switched off is selected.

By either method the TV will switch on. When the TV is operated for the first time, the following screen appears:

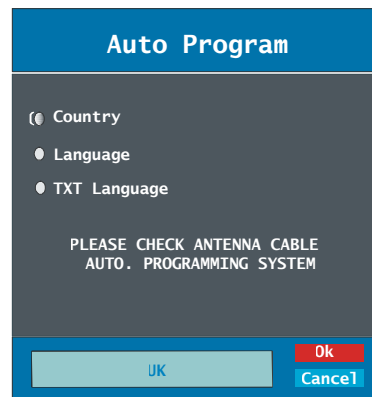

By pressing “◀” or “▶” button, adjust the **Country** item and press “▼” to highlight “**Language**” item. Use “◀” or “▶” button to set “**Language**”. Use “▲” or “▼” buttons to select “**TXT Language**” and set it by using “◀” or “▶” buttons. Press “**OK**” button to continue:

For more information on this process, see “**Install Menu**” section.

To switch the TV off:

- Press the “⏻ (stand-by)” button on the remote control or On/Off switch on the TV, so the TV will switch to stand-by mode.

To power down the Tv completely, press the Power On/Off button located at the REAR of the Tv. Or disconnect the mains plug from the supply.

Navigating the Menu System

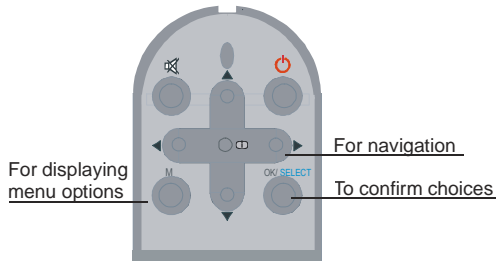

- 1- Press **M** to display the menu.
- 2- Press “▼” or “▲” button to select an icon. Press “▶” for more options.
- 3- Use “▼” or “▲” button to highlight.
- 4- Press “◀” or “▶” buttons to change the settings. Press **OK** to set as default.
- 5- To exit the menu or return from sub-menu screen, press **M**.

These explanations are available for the navigation of the whole Menu System. To select options that are explained in the following parts, refer to “Navigating The Menu System”.

Menu System

Picture Menu

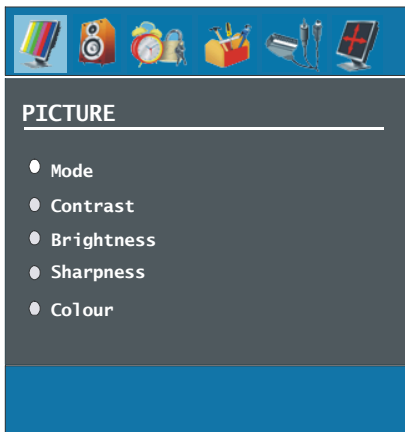

In picture menu if YPbPr or HDMI modes are selected, resolution information is displayed at the bottom of the menu OSD.

Mode

By pressing ▲ / ▼ button, select **Mode**. Press ◀ / ▶ button to choose from one of these options: **Cinema, Dynamic and Natural**.

Contrast/Brightness/Sharpness/Colour/Hue

By pressing ▲ / ▼ button, select the desired Option. Press ◀ / ▶ button to set the level.

Hint: Hue is displayed in picture menu when the TV receives an NTSC signal.

Colour Temp

- By pressing ▲ / ▼ button select **Colour Temp**.
- Press ◀ / ▶ to choose from one of these options: **Cool, Normal and Warm**.

Noise Reduction

By pressing ▲ / ▼ button select **Noise Reduction**. Press ◀ / ▶ to choose from one of these options: **Low, Medium, High or Off**.

Film Mode

Films are recorded at a different number of frames per second to normal television programmes.

By pressing ▲ / ▼ button, select Film Mode.

Press ◀ / ▶ button to set this feature On or Off. Turn this feature on when you are watching films to see the fast motion scenes clearly.

Picture Zoom

By pressing ▲ / ▼ button select **Picture Zoom**. Use ◀ / ▶ buttons, to change picture zoom to **Auto, 16:9, 4:3, Panaromic, 14:9 Zoom, Cinema, Subtitle, or Zoom**.

Reset

By pressing ▲ / ▼ button, select **Reset**. Press ▶ or “**OK**” button to reset the picture modes to factory default settings.

Store

- By pressing ▲ / ▼ button select **Store**.
- Press ▶ or “**OK**” button to store the adjustments. “**Stored**” will be displayed on the screen.

Sound Menu

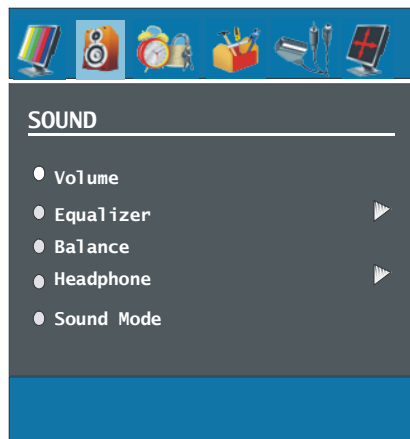

Volume

By pressing ▲ / ▼ select **Volume** . Press ◀ / ▶ button to change the level of the Volume.

Equalizer

By pressing ▲ / ▼ select **Equalizer**. Press ◀ / ▶ button to change the Equalizer setting. In equalizer menu, the mode can be changed to **Pop, Rock, Jazz, Flat, Classic or User**. Select the desired frequency by ▲ / ▼ button and increase or decrease the frequency gain by pressing ◀ / ▶ button.

Note: Equalizer menu settings can be altered only when the Equalizer Mode is in User.

Balance

By pressing ▲ / ▼ select **Balance**. Press ◀ / ▶ button to change the level of the balance. Balance level can be adjusted between -32 and 32.

Headphone

By pressing ▲ / ▼ button, select Headphone. Press ▶ button to enter headphone menu.

volume

By pressing ▲ / ▼ button, select Volume. Press ▶ button to increase hp volume level. Press ◀ button to decrease hp volume level. Headphone volume level can be adjusted between 0 and 63.

sound mode

By pressing ▲ / ▼ button, select Sound Mode. Press ◀ / ▶ button to change sound mode.

Sound mode is used to identify sound mode of the headphone and can be set to mono, stereo, dual I or dual II according to the transmission.

balance

By pressing ▲ / ▼ button, select Balance. Press ▶ button to increase balance to the right. Press ◀ button to decrease balance to the left. Balance level can be adjusted between -32 and +31.

Press the "M" button to return to the previous menu.

Sound Mode

By pressing ▲ / ▼ select **Sound Mode**. Press ◀ / ▶ button, you can select Mono, Stereo, Dual I or Dual II mode, only if the selected channel supports that mode.

AVL

By pressing ▲ / ▼ select **AVL**. Press ◀ / ▶ button to set the AVL as on or off.

Effect

By pressing ▲ / ▼ select **Effect**. Press ◀ / ▶ button to set Effect as on or off.

Dynamis Bass

Dynamic Bass is used to increase bass effect of the TV set.

By pressing ▲ / ▼ button, select Dynamic Bass. By pressing ◀ / ▶ button set Dynamic bass to Low, High or Off. It is not recommended to select High if listening at high volume levels.

Store

- By pressing ▲ / ▼ button select **Store**.
- Press ▶ or "OK" button to store the adjustments. "Stored" will be displayed on the screen.

Features Menu

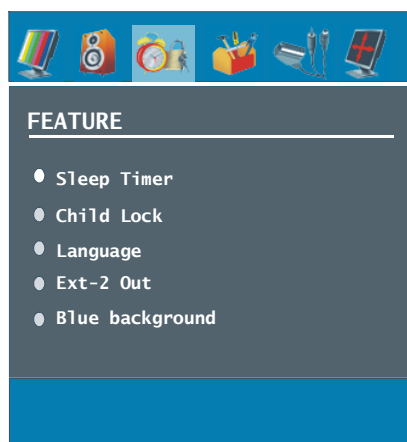

Sleep Timer

By pressing ▲ / ▼ select "**Sleep Timer**". Press ◀ / ▶ button to set the Sleep Timer.

The timer can be programmed between Off and 120 minutes in steps of 10 minutes.

Child Lock

By pressing ▲ / ▼ select **Child Lock**.

Press ◀ / ▶ button to set the Child Lock on or off. When on is selected, the TV can only be controlled by the remote control handset. In this case the control panel buttons will not work. Hence, if one of these buttons is pressed, "Child Lock On" will be displayed on the screen when the Menu screen is not visible.

Language

By pressing ▲ / ▼ button, select **Language**. Use ◀ / ▶ button to select the language.

EXT2 Out

By pressing ▲ / ▼ select **EXT2 Output**. Use ◀ / ▶ button, to set Ext-2 Out to **TV, EXT1, FAV or Audio YPbPr**.

Note: When TV Source is set to HDMI, HDMI Audio setting will be available among EXT-2 Out options.

Blue Background

You can set the TV to automatically change to a blue screen if the signal is weak or absent, or when there is no input from an external device.

The Blue Background feature can be turned on or off by pressing “◀” / “▶” button.

Menu Background

By pressing ▲ / ▼ button, select Menu Background. Transparency level is adjusted by pressing “◀” / “▶” button.

Menu Timeout

By pressing ▲ / ▼ button, select Menu Timeout. Press “◀” / “▶” button to change menu timeout to 15 sec, 30 sec or 60 sec.

Teletext Language

By pressing ▲ / ▼ button, select Teletext Language. Press “◀” / “▶” button to change Teletext Language to West, East, Turk/Gre, Cyrillic, or Arabic.

Default Zoom

Default zoom is a feature that provides the zoom mode of the TV set to be switched to the selected default zoom mode (Panoramic, 4:3, 14:9 zoom, 16:9) in case no WSS or 4:3 signal by end-user.

By pressing ▲ / ▼ button, select **Default Zoom**. You can set **Default Zoom** to **Panoramic, 4:3, 14:9 Zoom or 16:9** by pressing ◀ / ▶ button.

Install Menu

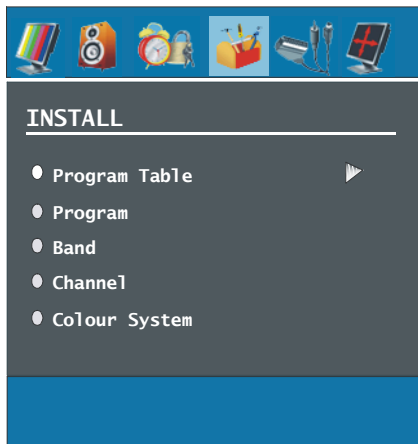

Program Table

By pressing ▲ / ▼ button, select Program Table. Press “▶” to display Program Table.

Program Table			
P01	BBC 1	P11	S 18
P02	C 04	P12	S 29
P03	C 05	P13	S 31
P04	BBC 1	P14	S 33
P05	CH 4	P15	S 34
P06	BBC 2	P16	S 35
P07	C 04	P17	S 36
P08	C 07	P18	S 37
P09	C 12	P19	S 40
P10	C 15	P20	C 21

Name	Insert
Delete	APS

By moving the cursor in four directions you can reach 20 programmes in the same page. You can scroll the pages up or down by pressing the navigation buttons to see all the programmes in TV mode (except the AV mode). By cursor action, programme selection is done automatically.

Name:

To change the name of a decided programme, select the programme and press the RED button.

The first letter of the selected name will be highlighted. Press ▲ / ▼ button to change that letter and “◀” / “▶” button to select the other letters. By pressing the RED button, you can store the name.

Insert:

Select the programme which you want to insert by navigation buttons. Press the GREEN button. By navigation buttons move the selected programme to the decided programme space and press the GREEN button again.

Delete:

To delete a programme, press the YELLOW button. Pressing the YELLOW button again erases the selected programme from the programme list, and the programmes below shift one up.

APS (Auto Programming System)

When you press the BLUE button for APS, Auto Programming System Menu will appear on the Screen.

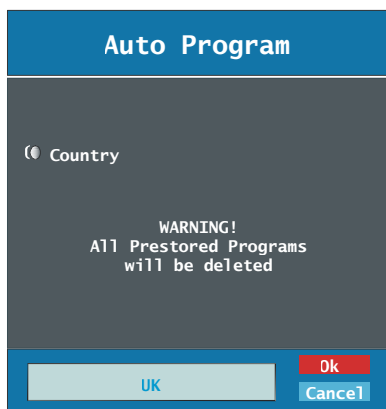

A.P.S. (Auto Programming System) Country

Press ◀ / ▶ button to select your country. If you want to exit from A.P.S. function, press the "BLUE" button.

When you press OK or RED button for starting APS, all stored programs will be erased and the following screen will be displayed:

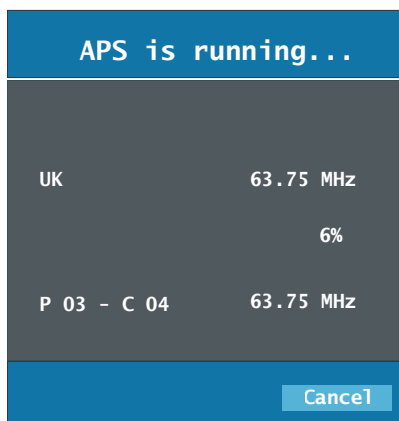

Whenever you press the "BLUE" button, A.P.S. function stops and Program Table appears on the screen. If you wait until the end of A.P.S., Program Table is displayed with the programmes found and located.

Program

By pressing ▲ / ▼ button, select Program. Press "◀" / "▶" button to select the program number. You can also enter a number via digit buttons on the remote control. There are 100 program storage between 0 and 99.

Band

Band can be selected either "C" or "S" by press "◀" / "▶" button.

Channel

Channel can be changed by "◀" / "▶" button or Digit Buttons.

Colour System

By pressing ▲ / ▼ button, select Colour System. Press "◀" / "▶" button to change the colour system to PAL, SECAM, PAL60 or AUTO.

If Sound System is set to I, SECAM is not available for the Colour System.

Note: In EXT mode, you can choose NTSC 3.58 and NTSC 4.43 as well.

Sound System

By pressing ▲ / ▼ button, select Sound System. Press "◀" / "▶" button to change the sound system to BG, I, L, L', DK.

Fine Tune

By pressing ▲ / ▼ button, select Fine Tune. Press "◀" / "▶" button to adjust the tuning.

Search

By pressing ▲ / ▼ button, select Search. Press "◀" / "▶" button to start program searching. You can also enter the desired frequency via digit buttons when search item is highlighted.

Store

By pressing ▲ / ▼ button, select Store. Press "▶" or "OK" button to store the adjustments. "Stored..." will be displayed on the screen.

Install menu in AV modes

The following screen appears in the install menu:

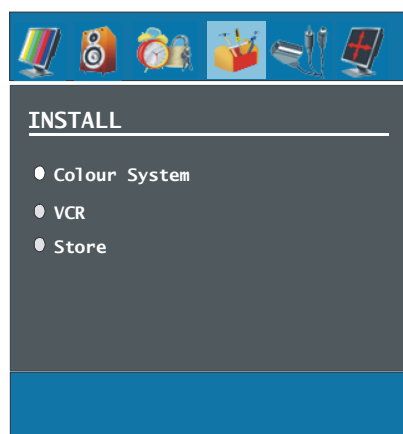

Colour System

By pressing ▲ / ▼ select **Colour System**. By pressing "◀" / "▶" button, you can change the colour

system to **PAL, SECAM, PAL 60, NTSC 4,43, NTSC 3,58** or **AUTO**.

VCR

By pressing ▲ / ▼ select **VCR**. By pressing “◀” / “▶” button, you can set the VCR to ON or OFF.

Store

By pressing ▲ / ▼ button, select Store. Press “▶” or “OK” button to store the adjustments. “Stored...” will be displayed on the screen.

Source menu

By pressing “◀” / “▶” button, select the fifth icon. Source menu appears on the screen.



In source menu, highlight a source by pressing ▲ / ▼ button and switch to that mode by pressing “▶” TV, EXT-1, EXT-2, **EXT-2 S**, **FAV**, **S-VIDEO**, **HDMI** and **YPBPR**.

Note: You can mark desired source options by pressing OK button. Therefore, when (AV) button is pressed, only the marked source options will be available.

Note: PC menu will not be active for TV sets without a PC input.

Other Features

TV Status

Programme Number, Programme Name, Sound Indicator and **Zoom Mode** are displayed on the screen when a new programme is entered.

Mute Indicator

It is placed in the upper side of the screen when enabled.

Mute

To cancel mute, there are two alternatives; the first one is pressing the  button and the second one is increasing the volume level.

AV Modes

By pressing the AV button you can switch your TV to AV modes (except being in teletext). Pressing this button consecutively will switch the TV in one of the optional AV modes: **TV, EXT1, EXT2, EXT2 S, FAV, S-VIDEO, HDMI** or **YPBPR**.

Personal Preference

By pressing PP button, you may change Picture Mode settings.

Zoom Modes

Zoom mode can be changed by pressing the **WIDE** button. You can change the screen size according to the picture aspect ratio. Select the optimum one from the following **ZOOM** modes.

Note:

- In YPBPR and HDMI modes, while in 720p-1080i resolutions, only FULL mode is available.

Auto:

When a **WSS (Wide Screen Signalling)** signal, which shows the aspect ratio of the picture, is included in the broadcast signal or the signal from an external device, the TV automatically changes the **ZOOM** mode according to the **WSS** signal.

- When the **AUTO** mode does not function correctly due to poor **WSS** signal quality or when you want to change the **ZOOM** mode, change to another **ZOOM** mode manually.

Zoom:

This uniformly stretches the left and right sides of a normal picture (4:3 aspect ratio) to fill the wide TV screen.

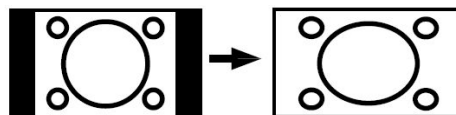

- For 16:9 aspect ratio pictures that have been squeezed into a normal picture (4:3 aspect ratio), use the **Full** mode to restore the picture to its original shape.

Cinema:

This zooms up the wide picture (16:9 aspect ratio) to the full screen.

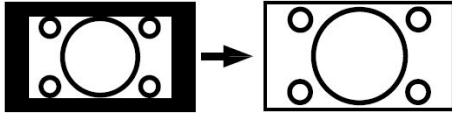

16:9 Zoom:

This zooms up the wide picture (16:9 aspect ratio) to the full screen.

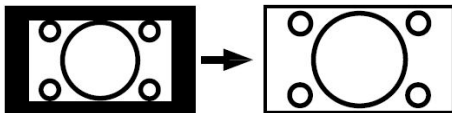

Subtitle:

This zooms up the wide picture (16:9 aspect ratio) with subtitles to the full screen.

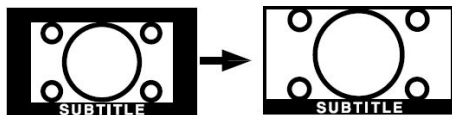

4:3

Use to view a normal picture (4:3 aspect ratio) as this is its original shape.

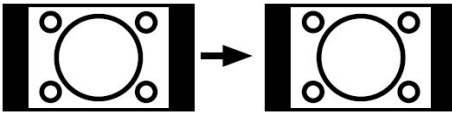

14:9 Zoom:

This zooms up the wide picture (14:9 aspect ratio) to the upper and lower limits of the screen.

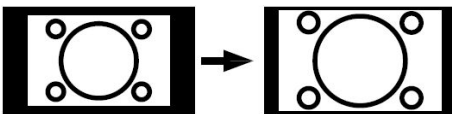

Panoramic:

This stretches the left and right sides of a normal picture (4:3 aspect ratio) to fill the screen, without making the picture appear unnatural.

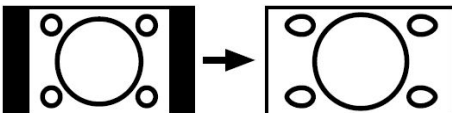

The top and bottom of the picture are slightly cut off.

Freeze Picture

You can freeze the picture on the screen by pressing the “OK” button.

Note: This feature will be unavailable to be used while watching YPbPr and HDMI sources.

Teletext

You can display Teletext information on your TV. Each channel which broadcasts teletext, transmits a page with information on how to use its teletext system (usually page 100). Depending on the TV channel, teletext is transmitted in different systems. The colours used in the options line correspond with the colour buttons of your remote control.

- Ensure that the TV is receiving a good signal, or some text errors may occur.
- When four coloured items appear at the bottom of the text page, Fasttext is available. Fasttext allows you to access pages quickly and easily. Press the corresponding coloured button to access the page.

Special Teletext Functions

“” To Display a page of text.

The view text services press “”. To return normal viewing press again. Programmes cannot be changed until text is cancelled.

- To select a page, press the number buttons or program buttons (P+, P-).
- To select index page, press “” button.
- To select superimposed over the programme on the screen, press “”.
- Press “” once to enlarge top half of the page, press again to enlarge the bottom half of the page. Press again to revert normal size.
- To discover solutions on quiz and games press “”.
- At times it is convenient to hold a page of text. Press “/” to hold a page. The page will be held on screen until the button pressed again.
- To select subcode pages press “”. Subcode pages are subsections of long Teletext pages that can only be displayed on the screen one section at a time.
- Time information will be displayed on screen after pressing “” button. If the programme does not have teletext transmission, no information will be displayed.

- When "⏏" button is pressed while in teletext mode, the screen will be splitted into two windows, one displaying the teletext and the other displaying the current channel. Press the "⏏" button or "TV/DTV" button to exit from teletext.
- To exit text press "⏏".

Note: *If the signal becomes insufficient, the teletext mode will be quitted.*

Fasttext

Your TV supports the 500 page Teletext system. When the page number of any of the 500 pages in memory is entered, the system will not search for the requested page; instead it will display the page automatically. If the requested page is not in memory, the system will search for the requested page number and save the 500 pages including the requested page into memory after finding it.

- Press the ▲ button to move the Teletext screen forward one page at a time.
- Press the ▼ button to move the Teletext screen backward one page at a time.

For Fasttext

The subject-heading for the information may have a particular colour.

- Press an appropriate **RED, GREEN, YELLOW** or **BLUE** button in order to reach the relevant page quickly.

TOP text

TOP text mode of operation will be activated automatically according to the transmission.

- If TOP text transmission is present, colour coded buttons will appear in status row.
- If TOP text transmission is not present, status row will not appear.

The subject-heading for information may be located in colored box.

In Top mode the "-P/CH" or "P/CH+" commands will request the next or previous page respectively. If TOP text transmission is not available, in case of operation of these commands, wraparound occurs. For example page 100 appears to be one greater than page 199.

Connect Peripheral Equipment

High Definition

Your LCD Television is capable of displaying High Definition pictures from devices such as a High Definition Satellite Receiver or DVD Player. These devices must be connected via the HDMI socket or Component Socket. These sockets can accept either 720p or 1080i signals.

Note: When it is desired to watch HDMI source with a DVI to HDMI cable; in order to enable audio, Audio Input (which is located at the left side of the antenna input) is to be used to get DVI device's audio signals.

Via The Scart

The TV has 2 Scart sockets. If you want to connect peripherals (e.g. video, decoder, etc.) which have Scart sockets to the TV, you can use SCART socket of the TV.

Note: *If an external device is connected via the Scart sockets, the TV will automatically switch to AV mode. If both sockets are employed at the same time, SCART 1 becomes the preferential.*

Via Aerial Input

If the device you want to connect does not have a Scart socket, you should connect it to the Aerial input of the TV.

If the VCR is connected via Aerial input, it is suggested to use Programme 0.

Decoder

If you are subscribed to cable TV offers, the organisation will supply you a corresponding decoder unit to allow the programmes to be unscrambled.

For further information consult your dealer.

Connect a decoder with an aerial socket to the TV

- Connect the aerial cable.

Connect a decoder without an aerial socket to the TV

- Connect the decoder to the EXTERNAL socket of TV with a RCA cable. Through the SCART/RCA socket of the decoder, you may attain a better display resolution.

TV And Video Recorder

- Connect the aerial cables.

Better picture quality can be obtained if you also connect a Scart cable to **SCART** sockets.

Playback NTSC

- Connect NTSC VCR player to a Scart socket of the TV.

Then, press the “**AV**” button to select EXT1 or EXT2.

Copy Facility

Source selection for **VCR** recording.

- Select **Feature** menu.
- Select **SCART 2 Out** by pressing ◀ / ▶ button.
- For copying the picture that comes from the tuner, select SCART 1.

Camera And Camcorder

To Connect To AV Input

Connect your camera or camcorder to AV input of the TV.

- Connect your equipment to the TV via **VIDEO** (yellow), **AUDIO R** (red) and **AUDIO L** (white) inputs. You must connect the jacks into the input with the same colour.

To Connect To S-VHS Input

Connect your camera or camcorder S-VHS input of the TV.

- Connect your equipment to the TV via S-VHS input and audio inputs of AV inputs by using S-VHS cables.

Connect The Decoder To The Video Recorder

Some video recorders have a special Scart socket for decoder.

- Connect a Scart cable to the Scart socket of your decoder and to the special Scart socket of your video recorder. Refer to the booklet of your video recorder.

Connecting Headphones (optional)

Use the stereo headphone socket of the TV, to connect headphones.

Note: *If you want to connect more equipment to your TV, consult your dealer.*

Tips

Care Of The Screen

Clean the screen with a slightly damp, soft cloth. Do not use abrasive solvents as they may damage the TV screen coating layer.

Poor Picture

Have you selected the correct TV system? Is your TV set or house aerial located too close to non-earthed audio equipment or neon lights, etc.?

Mountains or high buildings can cause double pictures or ghost images. Sometimes you can improve the picture quality by changing the direction of the aerial.

Is the picture or Teletext unrecognisable? Check if you have entered the correct frequency.

The picture quality may degrade when two peripherals are connected to the TV at the same time. In such a case, disconnect one of the peripherals.

No Picture

Is the aerial connected properly? Are the plugs connected tightly to the aerial socket? Is the aerial cable damaged? Are suitable plugs used to connect the aerial? If you are in doubt, consult your dealer.

No Picture means that your TV is not receiving a transmission. Have you selected the correct button on the remote control? Try once more.

Sound

You can not hear any sound. Did you perhaps interrupt the sound, pressing the  button?

Sound is coming from only one of the speakers. Is the balance set to one extreme? See **Sound** menu.

Remote Control

Your TV no longer responds to the remote control. Perhaps the batteries are exhausted. If so you can still use the local buttons at the bottom of the TV.

Appendix A: Aerial Connection

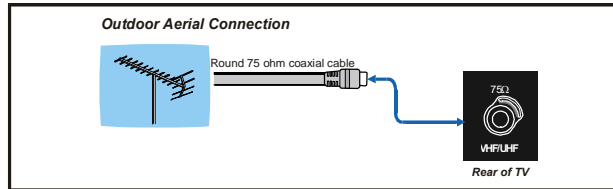

Appendix B: Connect Peripheral Equipment

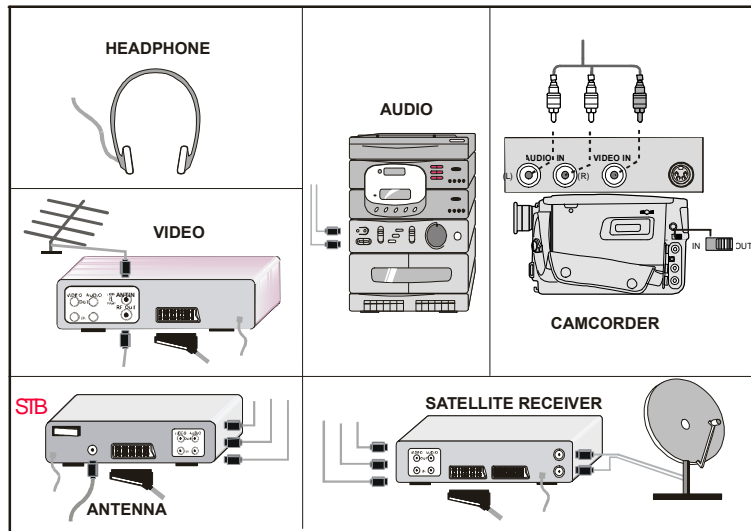

CAUTION



The lightning flash with arrowhead symbol, within an equilateral triangle, is intended to alert the user to the presence of un-insulated "dangerous voltage" within the products enclosure that may be of sufficient magnitude to constitute a risk of electric shock to the persons.



The exclamation point within an equilateral triangle is intend to alert the user to the presence of important operating and maintenance (servicing) instructions in the literature accompanying the appliance.

Correct disposal of this Product (Waste Electrical & Electronic Equipment (WEEE))

The crossed out "Wheellie bin" is intended to show that this appliance must not be placed with ordinary household waste at the end of its useful life. To prevent possible harm to the environment or human health from uncontrolled waste disposal, please keep separate from other household waste and recycle it responsibly to promote the sustainable reuse of material resources.



Household users should contact either the retailer where you purchased the product, or their local government office for details of where and how you can take this item for environmentally safe re-cycling.

Business users should contact their supplier and check the terms and conditions of the purchase contract. This product must not be mixed with other commercial wastes for disposal

User Help Guide

Should you have problems with this Tv please consult the guide below before calling the Technical Help Line.

SYMPTOM	POSSIBLE CAUSE	REMEDY
DEAD No Power	Supply not connected to Tv.	Ensure the Tv is connected to the mains and is turned on.
	TV not switched on.	Press the button at the Rear of the Tv adjacent to the mains input plug.
No Picture. Buttons lit Blue	Tv in Standby.	Press the Standby button on the Tv or the Remote Control
Screen lit but no picture (No Signal) on screen.	Aerial not connected.	Connect a suitable aerial or cable connection.
	Tv not tuned in.	See page 6 or 9 for tuning.
	Incorrect input selected or external source not turned on.	Press "Source" button to select required signal source, and ensure external source is turned on
Picture noisy or ghosting	Poor aerial signal.	Ensure the aerial and cable is in good condition. If using an indoor aerial try an external aerial. Note a Tv is only as good as the signal it receives
Teletext breaking up or freezing	As above	As above
HDMI screen will not hold picture size.	HDMI Signal source determines the picture size	Select picture size from HDMI source.
No Remote Control functions	Poor battery condition	Replace batteries every 6 months.
	Object blocking I/R signal to Tv	Remove objects in I/R signal path.

If you are still having difficulty please call the Technical help line. Ring 01422 263313 (Normal rates apply). Opening hours Mon-Fri 8 am - 8pm. Sat 9 am - 4pm. Sun 11am - 4pm "Bank holidays as Sun".

Care of the screen. Do not hit or bang the screen. It has over a million pixels which may be damaged by misuse. Occasionally one or two pixels may turn on or off fully. This is normal and is not a warranty issue.

To clean the screen, do NOT use solvents or petrol based fluids. Use a soft dry cloth. For stubborn sticky stains use a damp soft cloth with a dilute detergent.

Peripheral Equipment Connections

- Ⓐ Entrée S-VHS
- Ⓑ Entrée vidéo
- Ⓒ Entrées Audio
- Ⓓ Casque
- Ⓔ Entrée du fil électrique
- Ⓕ Bouton MARCHÉ/ARRÊT
- Ⓖ Pour utilisation de service uniquement
- Ⓗ Entrée HDMI
- Ⓘ SCART 2
- Ⓙ SCART 1
- Ⓚ Entrées des éléments audio
- Ⓛ Entrées des éléments vidéo (YpBpr)
- Ⓜ RF
- Ⓝ Entrée audio PC

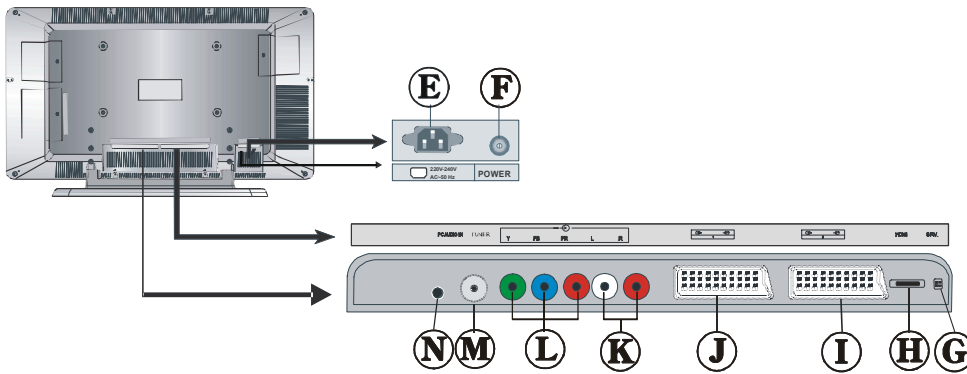
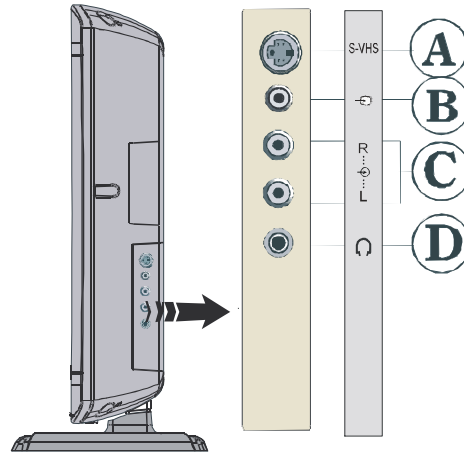

Note: Because FAV CVBS and SVHS Y are connected parallelly, the picture may blend if the two peripherals are used at the same time. Likewise, because SVHS C and SCART II R are connected parallelly, the picture may blend if the two peripherals are used at the same time. Thus these two are not to be used at the same time.

Important Instruction

For your own safety read following instruction carefully before attempting to connect this unit to the mains supply.

MAINS (AC) OPERATION

The wires in the mains lead are coloured in accordance with the following code :

**GREEN
&
YELLOW
(Earth
(if there is
earth cable)**

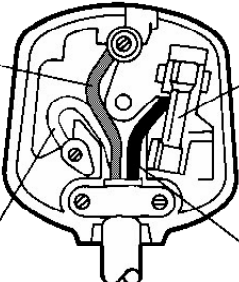

FUSE

**BROWN
(Live)**

**BLUE
(Neutral)**

IMPORTANT

For your safety, if the mains plug needs replacing, proceed as follows:
Connect the Green/Yellow wire to the Centre Pin (EARTH).
Connect the Blue wire to the (N) terminal (this may be coloured blue).
Connect the Brown wire to the (L) terminal adjacent to the fuse (this may be coloured brown).
This appliance must have a 5A fuse fitted.

CAUTION

TO PREVENT ELECTRIC SHOCK DISCONNECT FROM THE MAINS BEFORE REMOVING COVER. NO USER SERVICEABLE PARTS INSIDE. REFER SERVICING TO QUALIFIED SERVICE PERSONNEL.

SAFETY PRECAUTION

THIS EQUIPMENT MUST BE DISCONNECTED FROM THE MAINS WHEN NOT IN USE. DO NOT ALLOW THIS UNIT TO BE EXPOSED TO RAIN OR MOISTURE.

Specifications

TV BROADCASTING

PAL/SECAM B/G D/K K' I/I' L/L'

RECEIVING CHANNELS

VHF (BAND I/II)

UHF (BAND U)

HYPERBAND

CABLE TV (S1-S20/ S21-S41)

NUMBER OF PRESET CHANNELS

100

CHANNEL INDICATOR

On Screen Display

RF AERIAL INPUT

75 Ohm (unbalanced)

OPERATING VOLTAGE

230-240V AC 50 Hz

AUDIO

German+Nicam Stereo

AUDIO OUTPUT POWER (W_{RMS}) (%10 THD)

2 x 8

POWER CONSUMPTION (W)

180 W

3 W (Stand-by)

PANEL

16:9 display, 32" Screen Size

DIMENSIONS (mm)

DIMENSIONS (mm)				
D	L	H	Weight (kg)	
227	922	562	15,0	With foot
105	922	515	13,4	Without foot